

Service.



## Self-Study Programme 215

# Painting the Vehicle - The Topcoat

## Basic Principles

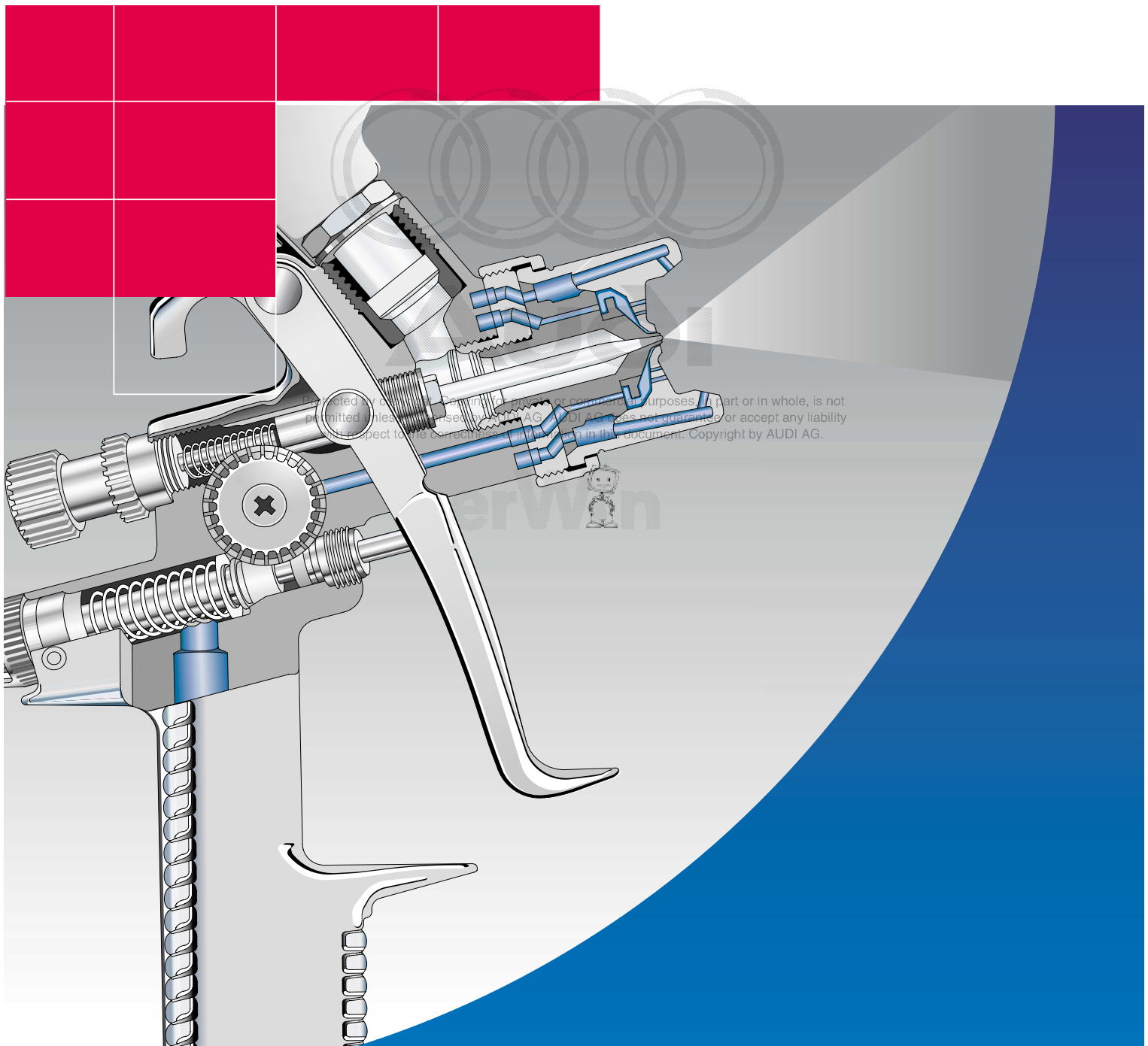

# Introduction

The first part of the topic **vehicle painting** is described in Self-Study Programme 214, "Painting the Vehicle - Pre-Treatment".

Self Study Programme 215, "Painting the Vehicle - The Topcoat", expands on this theme. It provides basic, specialist, as well as practical knowledge and supplements the subject matter of SSP 214.

Self-Study Programmes 214 and 215 were designed to provide an overview of the current state of vehicle paintwork.

- SSP 214:  
Painting the Vehicle – Pre-Treatment
- SSP 215:  
Painting the Vehicle - The Topcoat



**NEW**



**Caution  
Note**

**The self-study programme  
is not a workshop manual!**

Testing, adjustment and repair instructions  
may be found in the appropriate  
service material.



|                                                  |           |
|--------------------------------------------------|-----------|
| <b>Vehicle Painting – Basic Principles</b> ..... | <b>4</b>  |
| An introduction to colours .....                 | 4         |
| Composition of colours .....                     | 8         |
| Matching the colours .....                       | 10        |
| Types of topcoats .....                          | 16        |
| <br>                                             |           |
| <b>Equipment, Auxiliary Tools</b> .....          | <b>20</b> |
| Equipment in the paint workshop .....            | 20        |
| Spray chambers .....                             | 22        |
| Equipment for mixing the paint .....             | 24        |
| Tools and auxiliary devices .....                | 27        |
| Sanding tools .....                              | 29        |
| <br>                                             |           |
| <b>Application of the Topcoat</b> .....          | <b>34</b> |
| Mixing and applying the topcoat .....            | 34        |
| Basic requirements .....                         | 37        |
| Spray guns .....                                 | 38        |
| Drying .....                                     | 42        |
| <br>                                             |           |
| <b>Check your Knowledge</b> .....                | <b>46</b> |
| <br>                                             |           |
| <b>Glossary</b> .....                            | <b>50</b> |

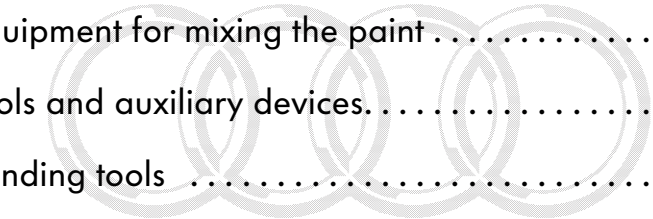

Protected by copyright. Copying for private or commercial purposes, in part or in whole, is not permitted unless authorised by AUDI AG. AUDI AG does not guarantee or accept any liability for the correctness of information in this document. Copyright by AUDI AG.

# Vehicle Painting – Basic Principles



## An introduction to colours

The colour of objects is a matter of perception, which depends upon the characteristics of the object, the lighting and the eye that observes it.

Colour is the brain's interpretation of various natural phenomena which are captured by our sensory organs: the eyes.

The phenomenon which stimulates the sensory organs is **light**.

The various sources of light - such as the sun, light bulbs, fluorescent substances and fire - affect the eyes directly.

Three elements must be present for the eyes to perceive **colour**:

- **The light**  
Illuminates the object.
- **The object**  
Reflects and absorbs light in various ways, depending on the composition and surface of the material.
- **The eye**  
Receives the light reflected by an object. It then conveys the information to the brain, which interprets it as form and colour.

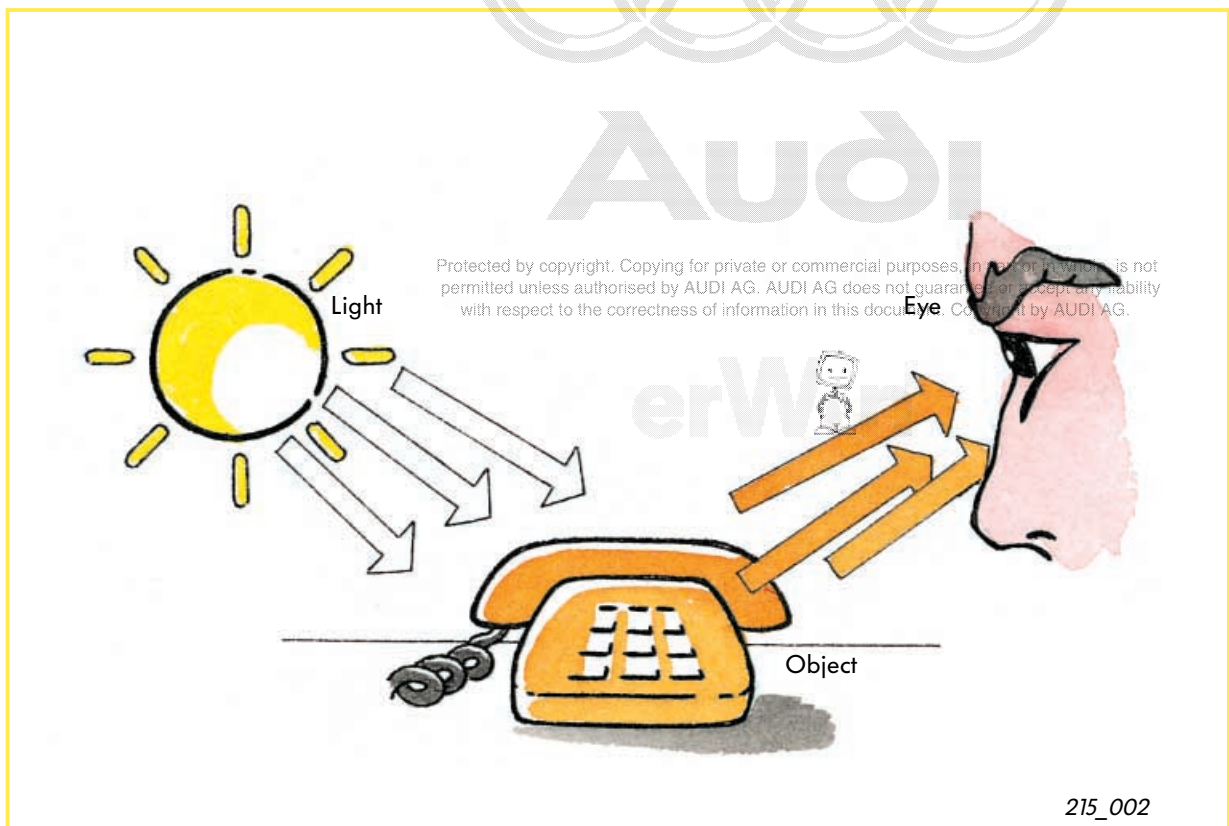

215\_002

Elements of colour perception

## Light

That which we call light is electromagnetic radiation with a wavelength from 400 to 700 nanometers (1 nanometer = 1 thousandth of a micrometer = 1 millionth of a millimetre).

Only these rays can stimulate the photosensitive cells of the human eye.

They make up the so-called **visible spectrum of electromagnetic radiation**.

The various wavelengths are perceived as different colours:

From violet (400 nm) to red (700 nm).

When light contains **the entire visible spectrum** and is distributed relatively evenly, it is called **white light**.

White light is a combination of all colours and is also perceptible to the eye.

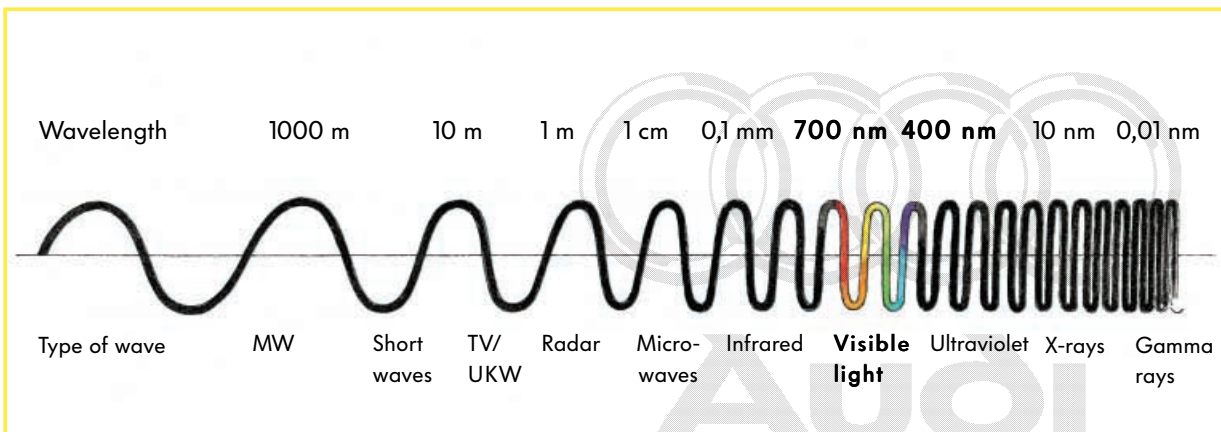

Electromagnetic rays

215\_003

Protected by copyright. Copying for private or commercial purposes, in part or in whole, is not permitted unless authorised by AUDI AG. AUDI AG does not guarantee or accept any liability with respect to the correctness of information in this document. Copyright by AUDI AG.

Issac Newton formulated a theory of the origin of the spectral colours.

When white light is directed through a transparent quartz prism, the light splits up into the colours of the rainbow.

The split is a result of each colour's various angles of refraction.

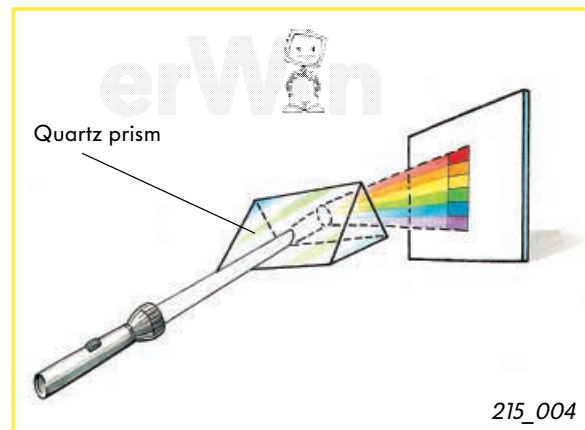

215\_004

Spectral analysis

# Vehicle Painting – Basic Principles



## The eye

The cells of a human eye contain sensitive substances which react to the rays of the visible spectrum.

Cells stimulated by incoming light send a nerve impulse to the brain.

All of the information which the brain receives from these millions of cells make up the field of vision: forms and colours.

There are three types of cells for the perception of colour:

- Cells sensitive to red light
- Cells sensitive to green light
- Cells sensitive to blue light

Colour perception is a result of the mixture of sensations of these three types of cells.

## The objects

We see everything around us in various colours. Objects receive the light of different sources of light.

The various materials which constitute an object can absorb all or part of the light and reflect the rest. The reflected light is received by the eye and recognised as colour.

### Example:

- An object appears red when it absorbs green and blue rays and reflects red rays.
- An object appears yellow when it absorbs blue rays and reflects red and green rays.

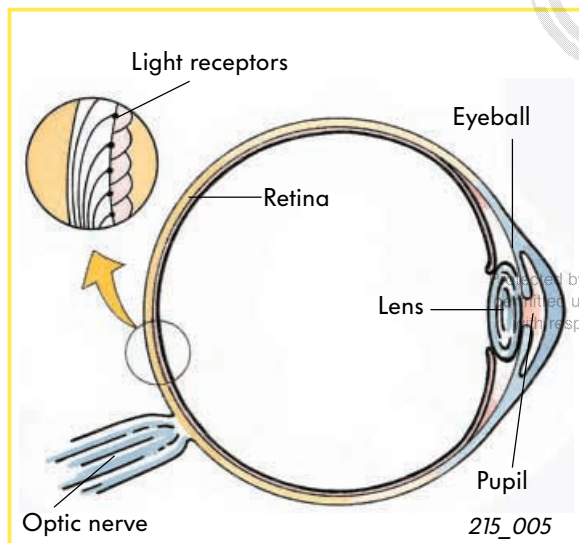

The human eye

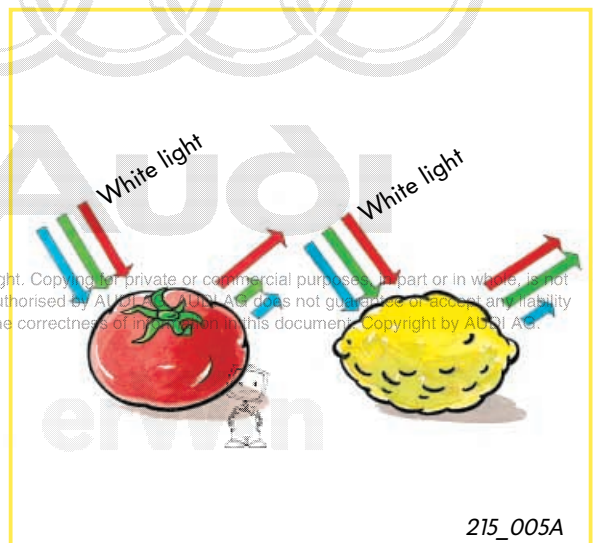

Absorption characteristics of objects

## Metamerism

The colour of an object depends upon the light which falls upon it.

Light can have various compositions. Daylight is bluish, light from a light bulb is reddish.

**Metamerism** means:

Two objects seen under one source of light have the same colour.

But view both objects under a different source of light and they will take on different colours.

To ensure that two objects **do not** show signs of colour variation (metamerism), both objects must have the same composition.

### Results for the repair paint job:

When reproducing a vehicle's colour from various base colours, it is very important to use the same pigments contained in vehicle's original paint job.

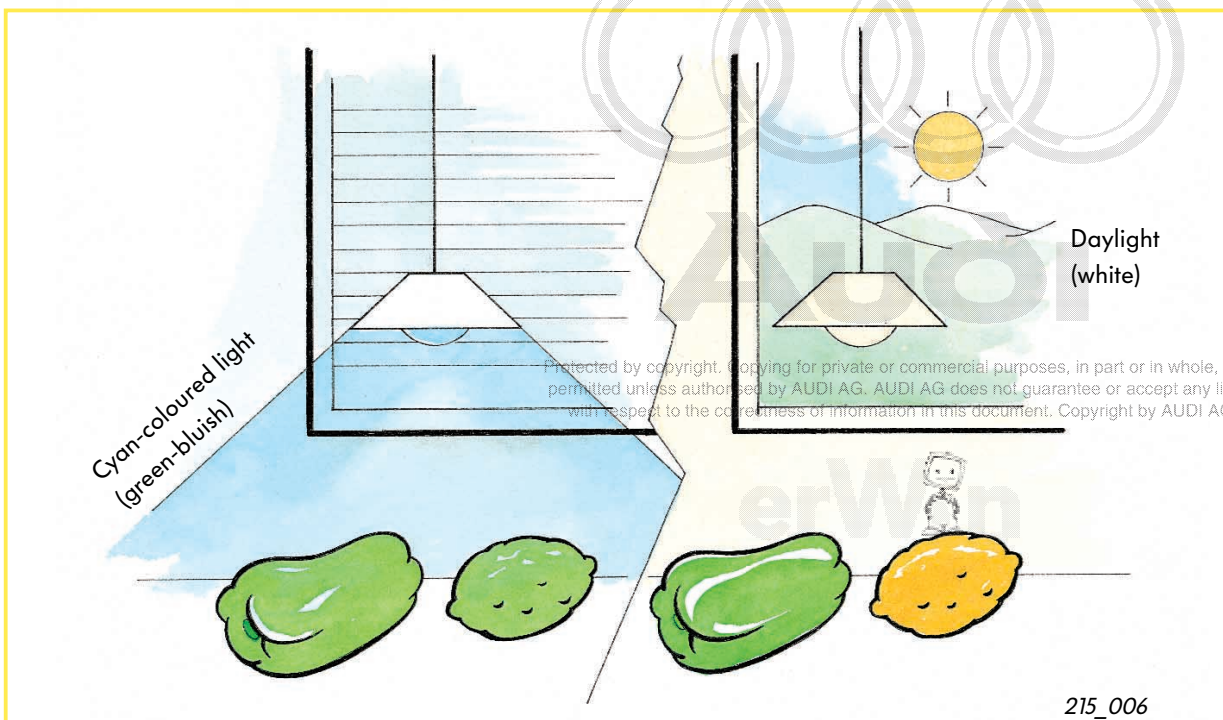

# Vehicle Painting – Basic Principles



## Composition of colours

### Light: Additive colour mixtures

The entire pallet of colours can be reproduced by mixing the three colours **red**, **green** and **blue** in various intensities.

That is why these three colours are called the **primary colours of light**.



215\_007A

The primary colours are added in various proportions; the combination is called additive colour mixtures.

The colour television is based on this principle (RGB screen).

- White - mixture of the three primary colours with maximum intensity.
- Black - mixture of the three primary colours with 0 intensity.

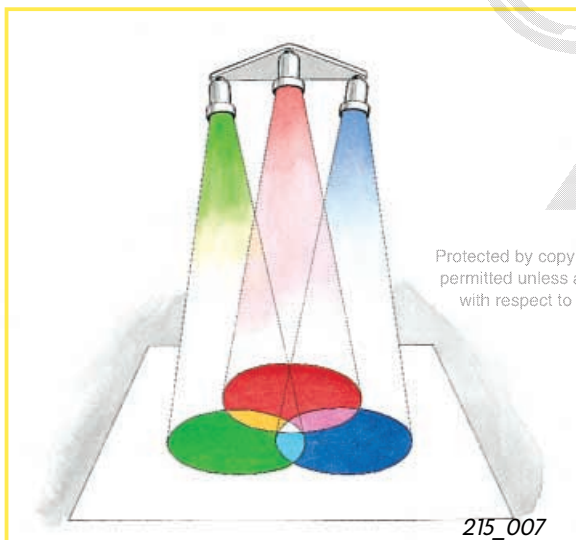

215\_007

Additive colour mixture

### Pigments: Subtractive colour mixtures

When a certain substance absorbs only one colour of light, i.e. one wavelength, the colour reflected is the result of two of the three colour receptors of the eye.

These three colours are called **primary pigment colours**.



215\_007B

- **Cyan** absorbs red.
- **Magenta** absorbs green.
- **Yellow** absorbs blue.

Mixing the pigments of two or three of these colours can reproduce the entire colour spectrum.

A mixture of cyan and yellow pigments absorbs red and blue light and reflects green light (secondary pigment colour).

The mixture of the three pigments does not result in white, because red, green and blue light is absorbed. The result is instead black, or a dark grey.



215\_008

Subtractive colour mixture

Protected by copyright. Copying for private or commercial purposes, in particular in whole or in part, is not permitted unless authorised by AUDI AG. AUDI AG does not guarantee or accept any liability with respect to the correctness of information in this document. Copyright by AUDI AG.

## Ostwald-chromatic circle, pigment-chromatic circle

The pigment-chromatic circle - also called the Ostwald-chromatic circle - consists of all of the primary pigment colours and their mixtures. It is a template representing all of the colours which can be mixed from yellow, red and blue.

The chromatic circle starts from a specific cyan pigment.

Replace one of the primary pigments with another, deviating pigment and the result is different chromatic circles with different shades of colour in various mixtures.

More than three colours are used in the mixing machine, however, because in reality not all colours can be mixed from the three primary colours.

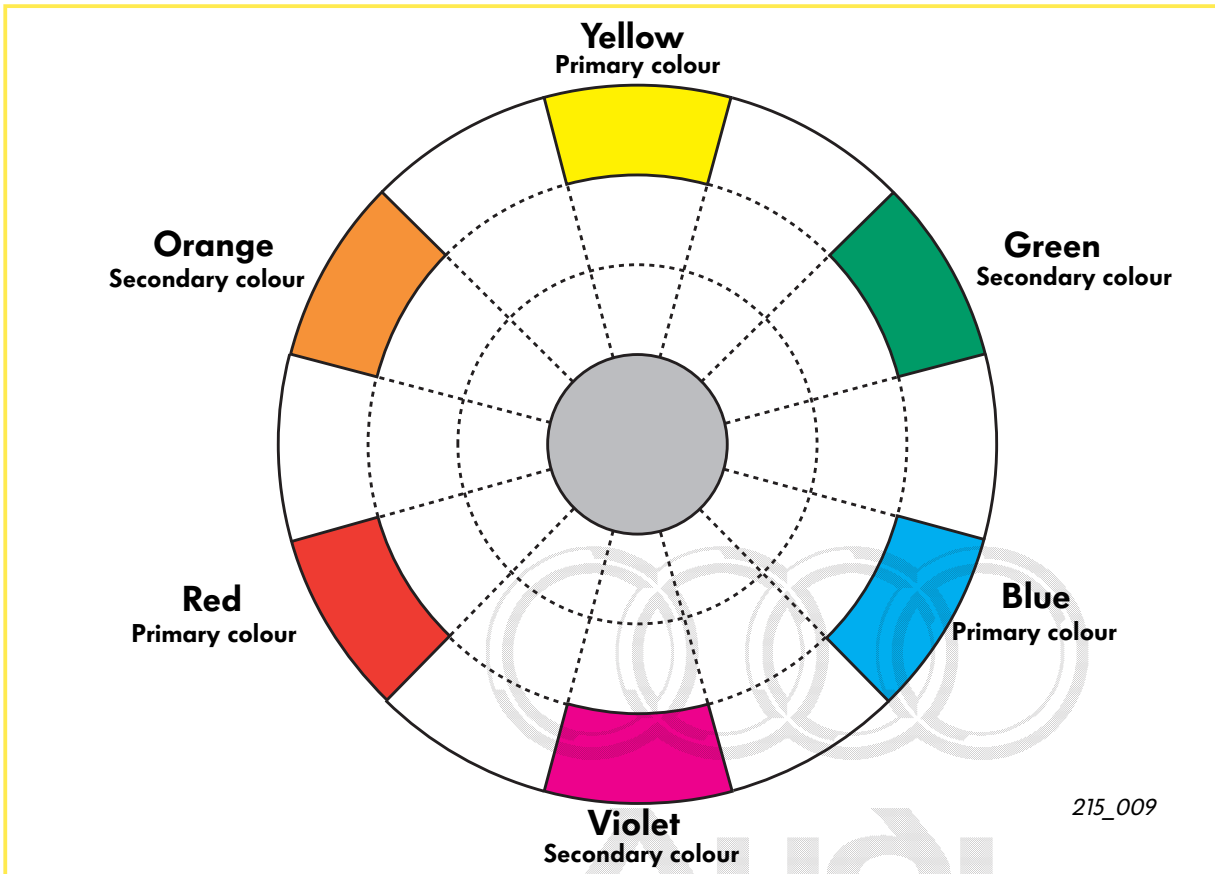

215\_009

Pigment-chromatic circle

The names cyan (sky blue) and magenta are often replaced by simply **blue** and **red**. Replacing the primary colours sky blue and fuchsia red with navy blue and orange-red, respectively, simplifies the names. These are then considered to be the three primary pigment colours. The mixtures of these three colours - **green**, **orange** and **violet** - are called secondary colours.

# Vehicle Painting – Basic Principles



## Matching the colours

### Identification of colour and tendencies

Knowing the vehicle's paint number is essential to producing a topcoat paint. The colour code can be found on the body's type plate.

The identifying colour code is compared with the standard pattern and its possible colour variations.

The colour variations result from analyses performed by the paint producers for the purpose of repair painting. The process includes a check for any possible deviations from the standard pattern.

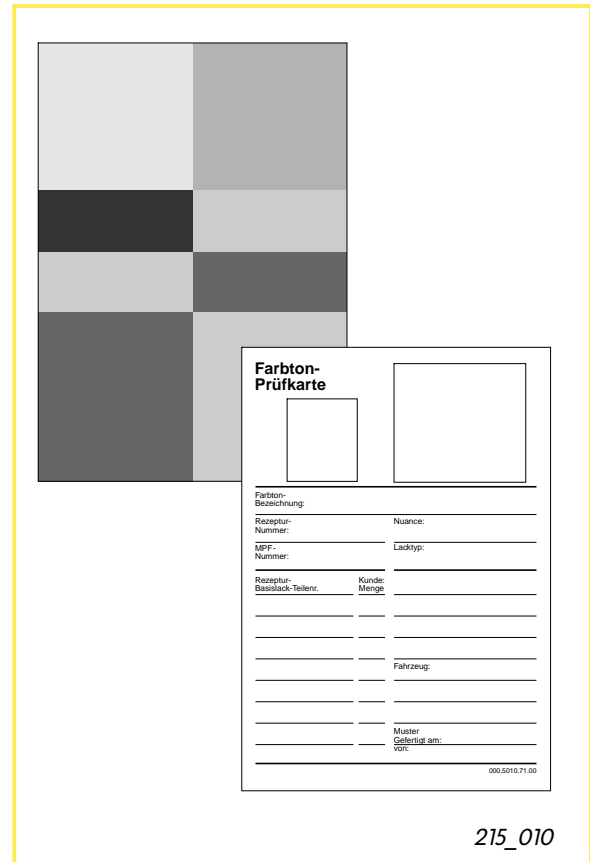

Type plate and colour code



Vehicle paint jobs with the same colour code should have identical colours. Possible reasons for deviations (colour variations) from the standard pattern include:

- **Different paint suppliers for series production**

The paints produced by the respective paint suppliers exhibit permissible deviations from the standard pattern. These differences can increase even more among the various paint suppliers.

- **Different painting lines in the factory**

Slight differences in the parameters - such as layer thickness, drying time and temperature - can be detected in the various painting lines.

- **Natural ageing of the paint**

These are changes in the tone over the years - due to fading, for example.

Protected by copyright. Copying for private or commercial purposes, in part or in whole, is not permitted unless authorised by AUDI AG. AUDI AG does not guarantee or accept any liability with respect to the correctness of information in this document. Copyright by AUDI AG.



## Painting samples

The repair paint, along with the chosen colour, is mixed according to the instructions on microfilm. To ensure that the choice of paint is correct, a sample must first be sprayed.

The following must be taken into consideration:

- For single-coat painting, the 2C paint must be diluted with hardener and thinner before the vehicle can be painted.
- For two-coat painting, thinner must be used during application of the paint, which is then coated with clear lacquer.
- Only compare the colour after the sample is completely dry (a small kiln may be helpful).
- The application of a topcoat on a sample should be carried out under the same conditions as on the vehicle.
- Samples used must have contrast marks (black lines on a white background, or black and white rectangles).



Contrast marks

## Comparison of the sample with the vehicle paint

The following results are possible:

- If the sample has the same colour as the vehicle paint, then the mixed colour can be applied to the part that is to be painted.
- If the colour of the sample is different from the vehicle paint, then the colour needs to be corrected.



An **analysis of the colour deviation tendencies** must be performed before the colour can be corrected.

Protected by copyright. Copying for private or commercial purposes, in part or in whole, is not permitted unless authorised by AUDI AG. AUDI AG does not guarantee or accept any liability with respect to the correctness of information in this document. Copyright by AUDI AG.



# Vehicle Painting- Basic Principles



## Analysis of the tendencies

The following colour deviations can occur:

- **Tone** compared to adjacent surfaces
- **Purity** of colour
- **Brightness** of colour

### Deviation in tone

A colour sample is placed in the pigment-chromatic circle, and a shift in one of the two directions is detected:

One of the two tones is intensified.

### Deviation in purity

A colour sample is placed in the pigment-chromatic circle, and a colour shift toward the centre of the chromatic circle or outer ring is detected.

The pure colours are located on the edges of the pigment-chromatic circle. Towards the circle's centre, the colours become "dirtier" due to mixing with other colours.

The mixture of all of the colours without any tendencies takes place in the centre of the circle. Which means, black and all levels of grey are produced until finally white is reached.

### Deviation in brightness

A colour sample is placed in the pigment-chromatic circle, and it is identical with the position of the vehicle paint. The colour shift, however, can be seen one level higher or lower, that is, one colour brighter or darker.

The next page shows you an example of colour deviations.

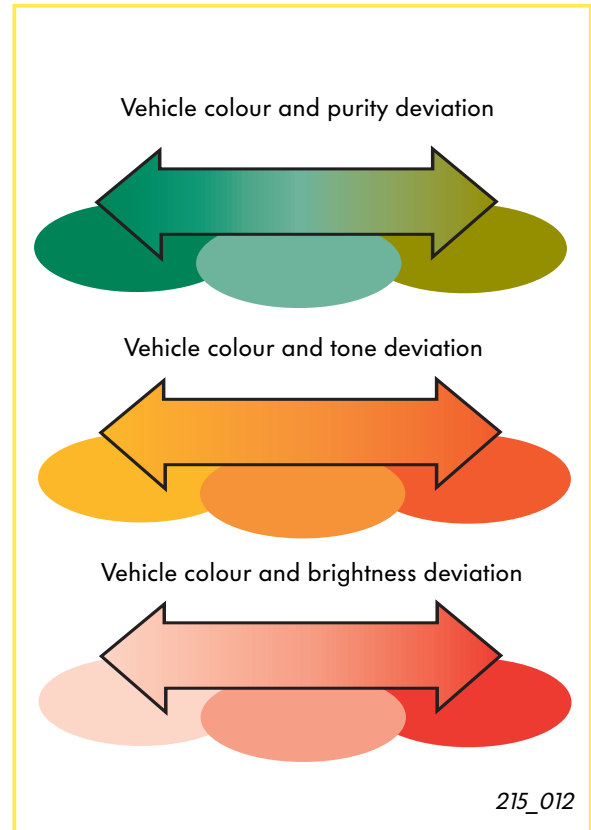

Tendencies

Protected by copyright. Copying for private or commercial purposes, in part or in whole, is not permitted unless authorised by AUDI AG. AUDI AG does not guarantee or accept any liability with respect to the correctness of information in this document. Copyright by AUDI AG.



## Concrete example of colour deviations

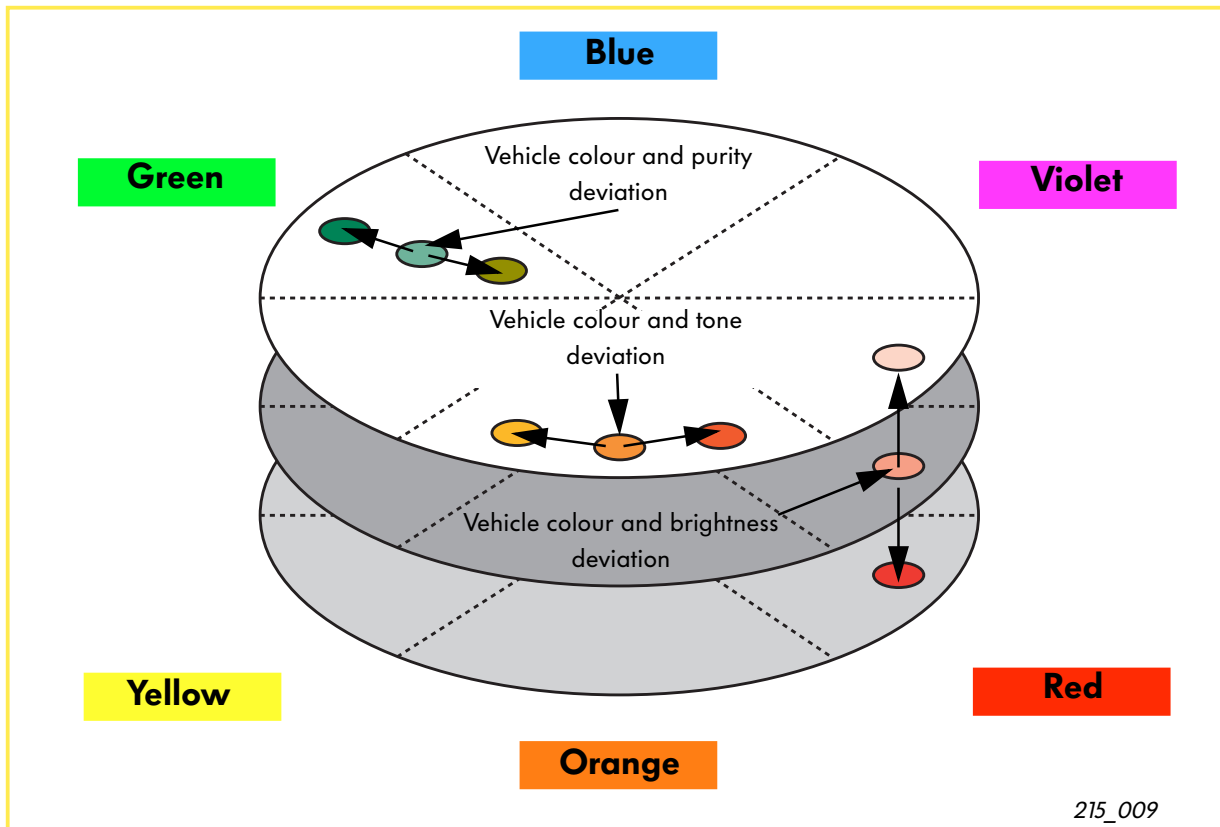

Analysis of colour deviation

- **Deviation in tone**

If the colour of the vehicle is orange:  
The colour sample can deviate in the direction of red or yellow. As a result, the vehicle colour will be either a reddish or yellowish orange.

- **Deviation in brightness**

If the colour of the vehicle is red:  
The tone is correct but the colour sample can deviate in the direction of dark red (darker paint) or light red (lighter paint).

- **Deviation in purity**

If the colour of the vehicle is green:  
The colour sample can have a deviation in the direction of either a more lively, pure green or a "dirtier" green (such as olive).

For private or commercial purposes, in part or in whole, is not permitted unless authorised by AUDI AG. AUDI AG does not guarantee or accept any liability with respect to the correctness of information in this document. Copyright by AUDI AG.



# Vehicle Painting- Basic Principles



## Correcting colour deviations

Colour can be corrected by adding base paint. The paint added shifts the colour of the mixed paint in the chromatic-circle direction of the vehicle's colour.

**Chromatic colours (= colours with a clearly defined colour trend, such as red and green)** usually require a tone correction, and often a brightness adjustment.

Purity correction is most often necessary with **achromatic colours (= colours with a neutral tendency, such as white, grey, beige)**.

### Tone correction

A base paint, which counteracts the tendencies of the deviation determined, is added in order to correct the tone.

If a colour sample of a green paint has become a bit too yellow, then a blue or green-bluish base paint is added.



A base paint is added to preclude the possibility of a **metamerism** effect (deviation of the colour of an object when viewed under different sources of light).



Tone correction

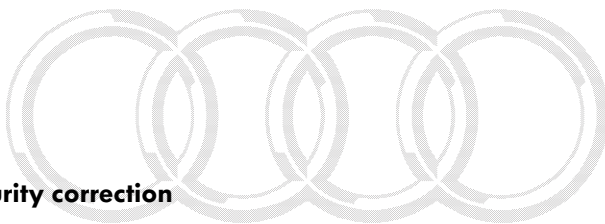

### Purity correction

A paint with the exact opposite colour in the chromatic circle (= complementary colour) is used to correct the purity.

If a colour sample of a grey paint has become a bit too yellow, then a more violet or bluish base paint is added.

Protected by copyright. Copying for private or commercial purposes, in part or in whole, is not permitted without the prior written consent of AUDI AG. AUDI AG does not guarantee or accept any liability with respect to the correctness of information in this document. Copyright by AUDI AG.



Purity correction



## Brightness correction

Two options are available for correcting the brightness or brilliancy:

### Darkening the topcoat

- For chromatic colour mixtures (such as red and green), black base paint is added.
- For achromatic colour mixtures (such as white and grey), the predominant chromatic base colour is added to the original composition.

### Lightening the topcoat

- White is added to pastel or mono colours.
- The metallic primary colour with the largest grain is added to metallic colours. White may not be added because it cancels out the metallic effect.

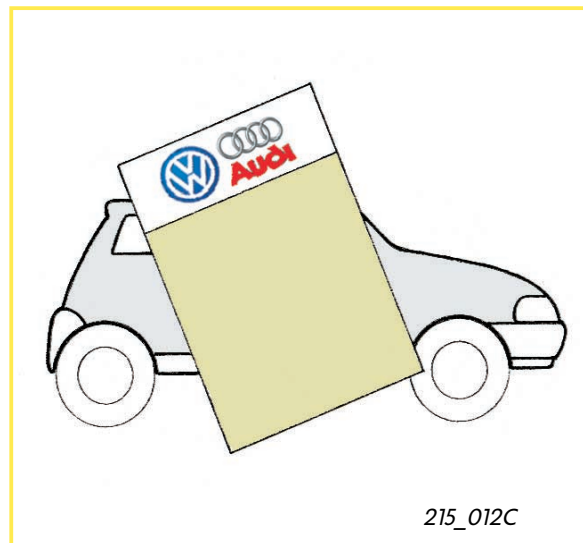

Brightness correction

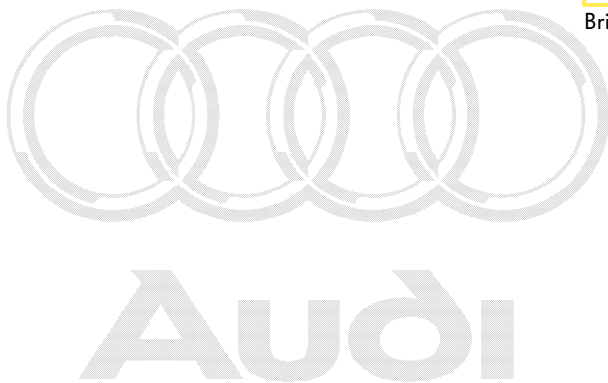

Protected by copyright. Copying for private or commercial purposes, in part or in whole, is not permitted unless authorised by AUDI AG. AUDI AG does not guarantee or accept any liability with respect to the correctness of information in this document. Copyright by AUDI AG.



# Vehicle Painting - Basic Principles



## Types of topcoats

Various procedures are employed for applying the topcoat. **The one-coat procedure** and **the two coat procedure** are used most often. Certain two-coat paints with a pearl effect require the **three-coat procedure**.

### Topcoat and type of application

The topcoat is resistant to sun rays, moisture, friction, etc. and protects the underlying layers. The application of the topcoat is the decisive criterion for assessing the quality of a paint job. Colour and shine are the decisive factors for the appearance of the paint job. Currently acrylic-polyurethane paints are used in vehicle repair due to their excellent finishing and protection properties. They are used as single-layer as well as double-layer topcoat paints.

### Single-layer topcoat

The paint coat is responsible for all of the important properties, such as resistance, hardness and degree of shine.

### Double-layer topcoat

The two-layer base (base paint) is responsible for the colour. All of the remaining properties are taken care of by the clear lacquer.

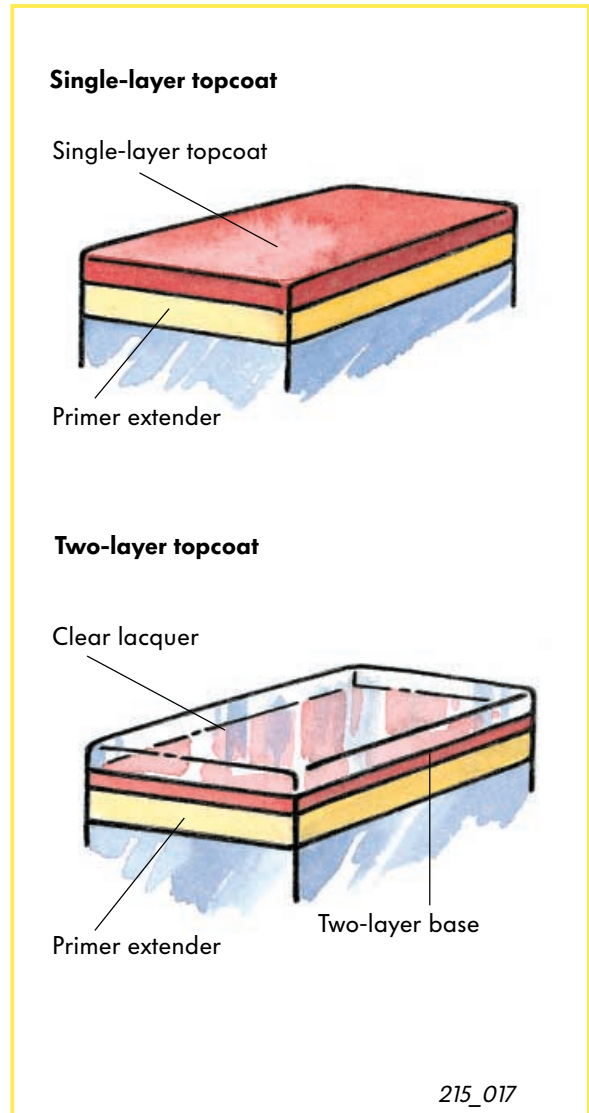

Single-layer and two-layer topcoats

Protected by copyright. Copying for private or commercial purposes, in part or in whole, is not permitted unless authorised by AUDI AG. AUDI AG does not guarantee or accept any liability with respect to the correctness of information in this document. Copyright by AUDI AG.



**One-coat paint and clear lacquer are two-component acrylic paints which are nearly identical in their application.**

## Types of topcoats

In the **single-layer procedure**, the single-layer topcoat, also called uni-topcoat, is applied with many covering pigments.

The **two-layer procedure** was developed mainly for the two-layer metallic topcoat. There are also uses for two-layer topcoats with permanent colours (uni-base paint). Since the introduction of the pearl effect, the two-layer procedure has been used for this type of paint.

The desired colour effect depends completely on the thickness of the coat of paint and the base to

which it is applied.

The **three-coat procedure** is often required for pearl-effect paint jobs.

Before the application of the pearl base, a colour base must be applied to the entire repaired area to ensure that the undercoat is covered.

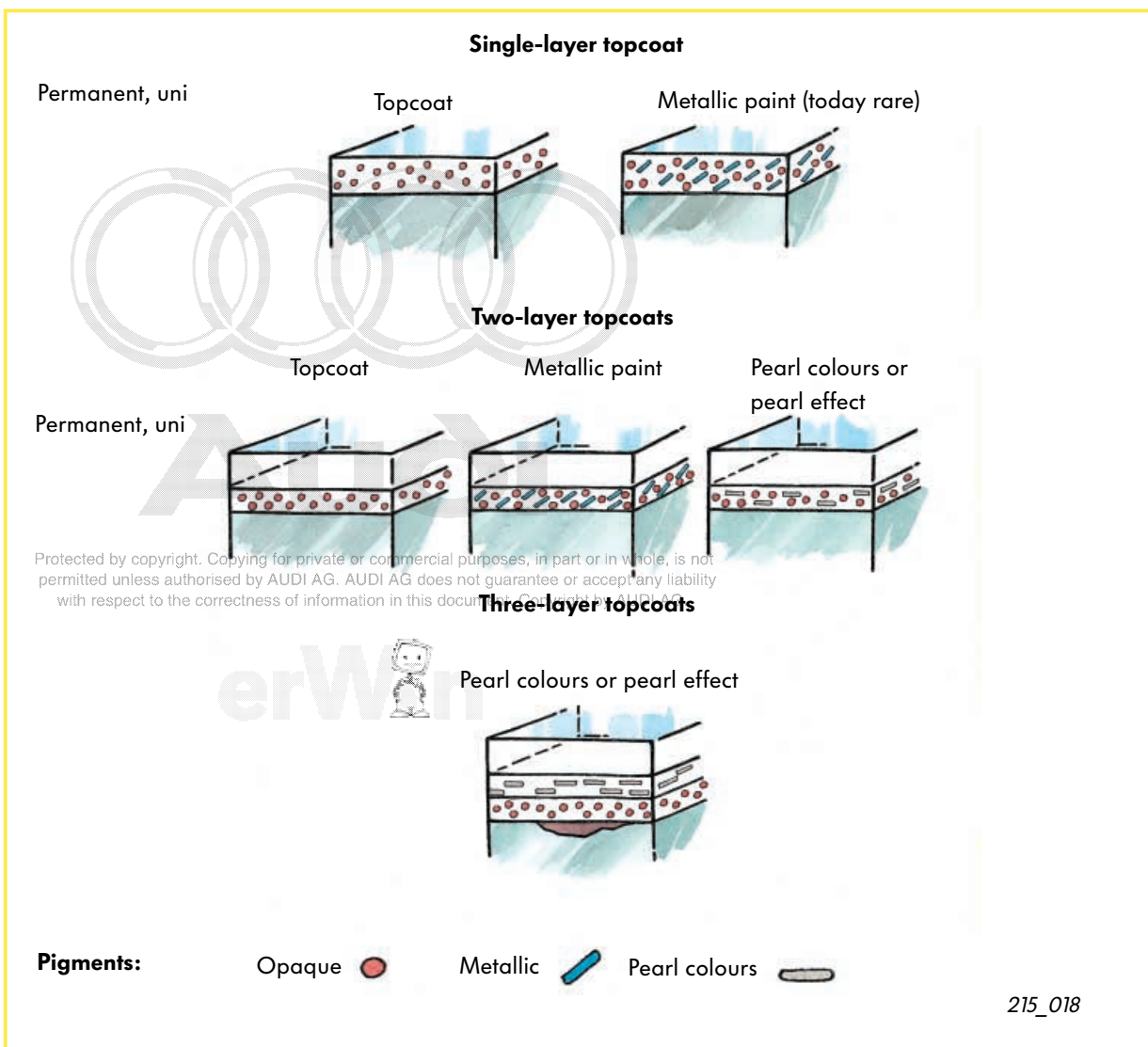

# Vehicle Painting - Basic Principles



## Pigmentation of the topcoat

Topcoats may contain various types of pigments. These pigments determine the colour and the effect of the paint job.

Pigments can be divided into three categories:

- Topcoat pigments
- Metallic pigments
- Pearl-effect pigments

### Topcoat pigments

The topcoat pigments are mineral or organic substances which are colour-fast and opaque. These pigments can be red, white, green or blue.

### Metallic pigments

Metallic pigments are very fine aluminium platelets.

They provide opacity and at the same time yield a metallic mirror finish. This finish takes on different appearances depending on the size and shape of the metallic pigment.

The combination of metallic pigments and topcoat pigments produces metallic colours such as metallic red or metallic blue.

If metallic pigments are used alone - i.e. without topcoat pigments - then the topcoat is called "silver", "silver-grey" or "metallic grey".

Protected by copyright. Copying for private or commercial purposes, in part or in whole, is not permitted unless authorised by AUDI AG. AUDI AG does not guarantee or accept any liability with respect to the correctness of information in this document. Copyright by AUDI AG.

### Pearl-effect pigments

The pearl-effect pigments (pearl colours) are produced from artificial materials and then coated with titanium oxide or iron oxide.

The grain and coating of the pigments are transparent.

Reflections and light refractions produce the chromatic effect (colour nuances) when rays of light penetrate the pigment.

The thickness of the oxide layer determines the pearl effect: reddish, white, violet or golden.

In order to attain complete opacity, the pearl-effect pigment must be mixed with the topcoat pigment. Only then will the base be completely covered.

Without the topcoat pigment, the undercoat colour alters the pearl effect.

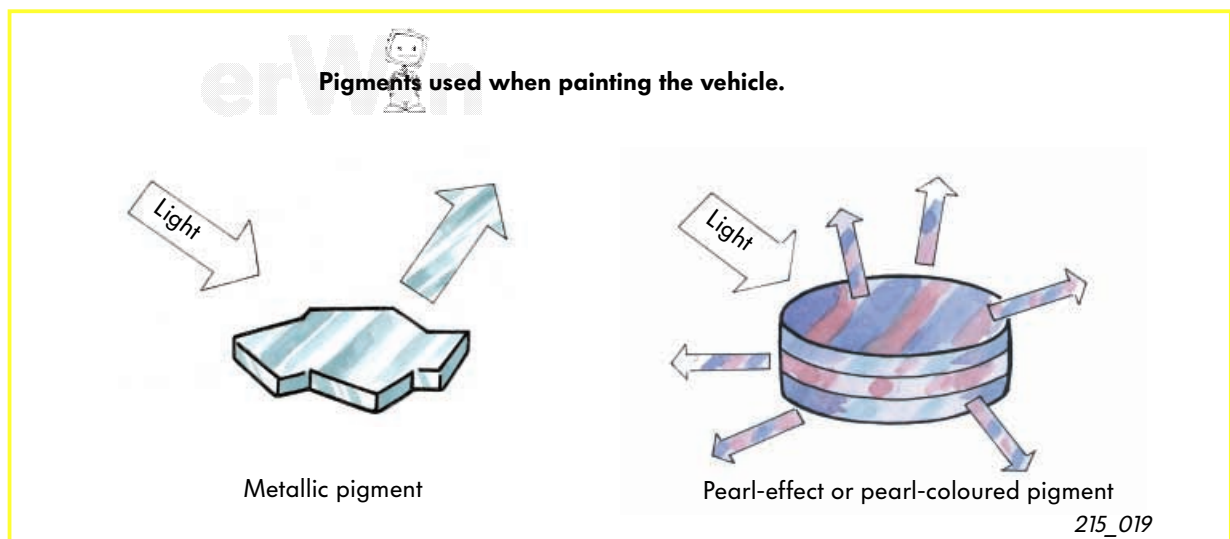

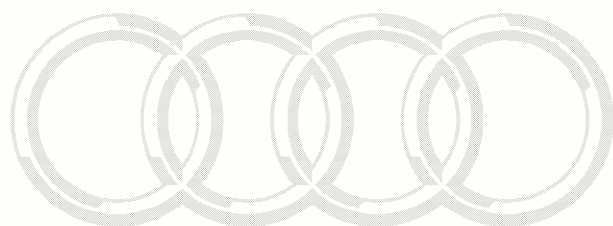

# Audi

Protected by copyright. Copying for private or commercial purposes, in part or in whole, is not permitted unless authorised by AUDI AG. AUDI AG does not guarantee or accept any liability with respect to the correctness of information in this document. Copyright by AUDI AG.



# Equipment, Auxiliary Tools

## Equipment in the paint workshop

To perform high-quality paint jobs, while observing all of the prescribed safety regulations, the paint workshop must possess the necessary equipment and the appropriate auxiliary tools.

To achieve a high-quality paint finish at a reasonable price: All facilities, such as the preparation areas or spray chambers, all devices, such as compressors or distribution networks, all tools, such as spray guns or sanding machines, must be selectively and efficiently operated by **trained workshop personnel**.



The **safety and environmental procedures** are not a part of Self-Study Programmes 214 and 215.

Please refer to the customer-service materials for information on safety and ambient conditions when painting in the workshop.



- 1 Intake and exhaust ventilation with heating
- 2 Injection channel with filter cover
- 3 Suction removal
- 4 Adjustment flap with drive
- 5 Control panel
- 6 Curtains for flexible separation
- 7 Movable infrared beam field

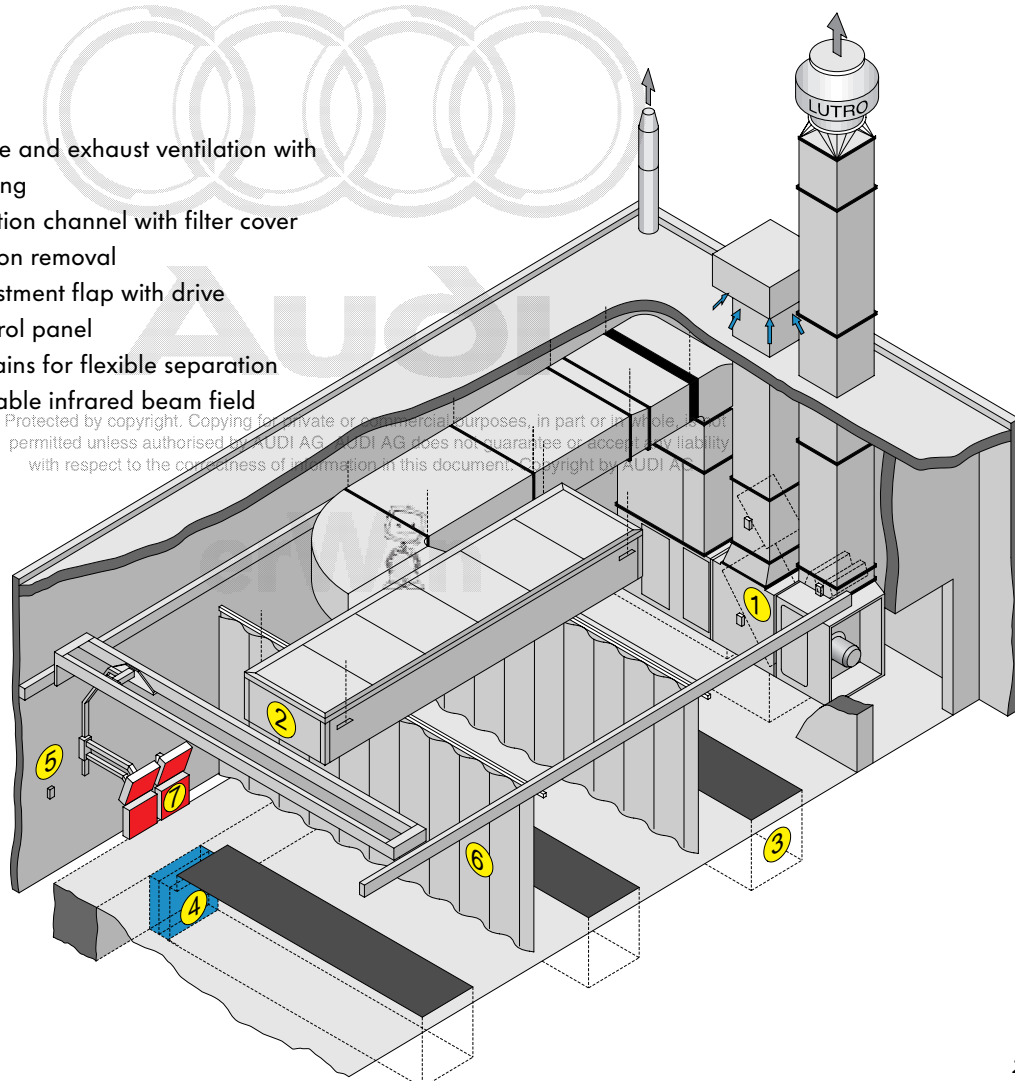

Protected by copyright. Copying for private or commercial purposes, in part or in whole, is not permitted unless authorised by AUDI AG. AUDI AG does not guarantee or accept any liability with respect to the correctness of information in this document. Copyright by AUDI AG.

215\_020

Suction removal of extender and sanding dust

A modern paint workshop should be equipped with the following facilities, devices and tools:

- **Sanding tools**

Manual, electric and pneumatic tools.

- **Tools for applying paint**

Spray guns

- **Devices for mixing the paint**

Mixing bench, microfilm reading device, precision scale, mixing stick, measuring stick, funnel viscometer, viscosity measuring beaker, paint filter

- **Auxiliary tools and devices**

For cleaning the parts: towels, soft cloths and dust cloths

For cleaning the spray guns: spray-gun cleaning facilities

For air supply: compressor, filter and pressure reducer

- **Sanding and priming equipment**

Under-pressure levels

- **Facility for applying paint**

Spray chamber

- **Facilities for drying paint**

Drying chamber, infra-red devices, kiln



Protected by copyright. Copying for private or commercial purposes, in part or in whole, is not permitted unless authorised by AUDI AG. AUDI AG does not guarantee or accept any liability with respect to the correctness of information in this document. Copyright by AUDI AG.

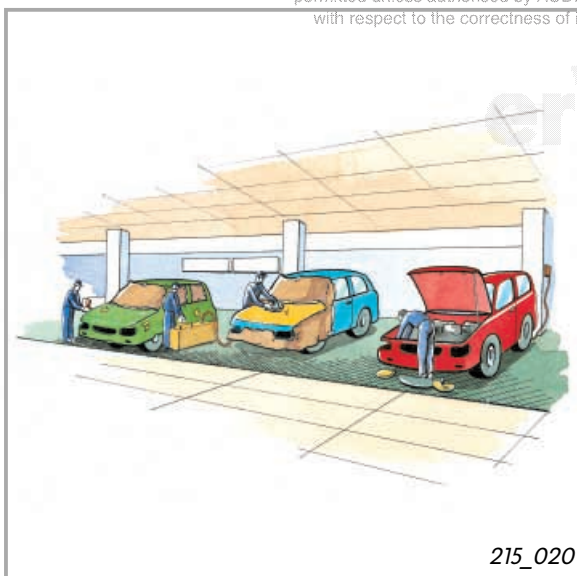

215\_020

Preparation area



215\_021

Spray chamber

# Equipment, Auxiliary Tools

## Spray chamber

The spray chamber is the most important facility for carrying out a high-quality paint repair job.

Regular maintenance and care is essential to ensure the proper functioning of the spray chamber - as well as a good paint job.

The spray chamber is a closed room in which the vehicle or part to be painted is placed. It is equipped with vertical air circulation with induced downward flow, which carries off the spray mist.

The air is directed from above by ceiling filters into the cabin and then warmed to the desired temperature by the heating system .

The air is guided to the floor area - by the way of the object - and then sucked out via a paint-stop filter.

Ceiling and paint-stop filters must be exchanged every so often, depending on the number of operating hours.

The air passes through an active carbon filter to prevent solvents from being released into the environment. These filters must be replaced every so often, depending on the number of operating hours.

Care and maintenance procedures include:

Exchanging filters, cleaning the walls and luminous strips, as well as maintenance of the motor, burners and all add-on units.

The volume of air blown into the cabin is slightly greater than the volume suctioned out.

A slight excess of pressure is thus generated which spreads over grooves, seals and door gaps.

Without this excess of pressure, unfiltered air from outside could make its way into the cabin and contaminate the painted areas.

Luminous strips are located on the slanted part of the ceiling and, if possible, on the sides in order to ensure good lighting conditions all around.

A combined spray/drying cabin with the drying chamber located on one side is the type most commonly used.

All-in-one spray/drying cabins have a lower capacity and are usually preferred by smaller operations.



Protected by copyright. Copying for private or commercial purposes, in part or in whole, is not permitted unless authorised by AUDI AG. AUDI AG does not guarantee or accept any liability with respect to the correctness of information in this document. Copyright by AUDI AG.



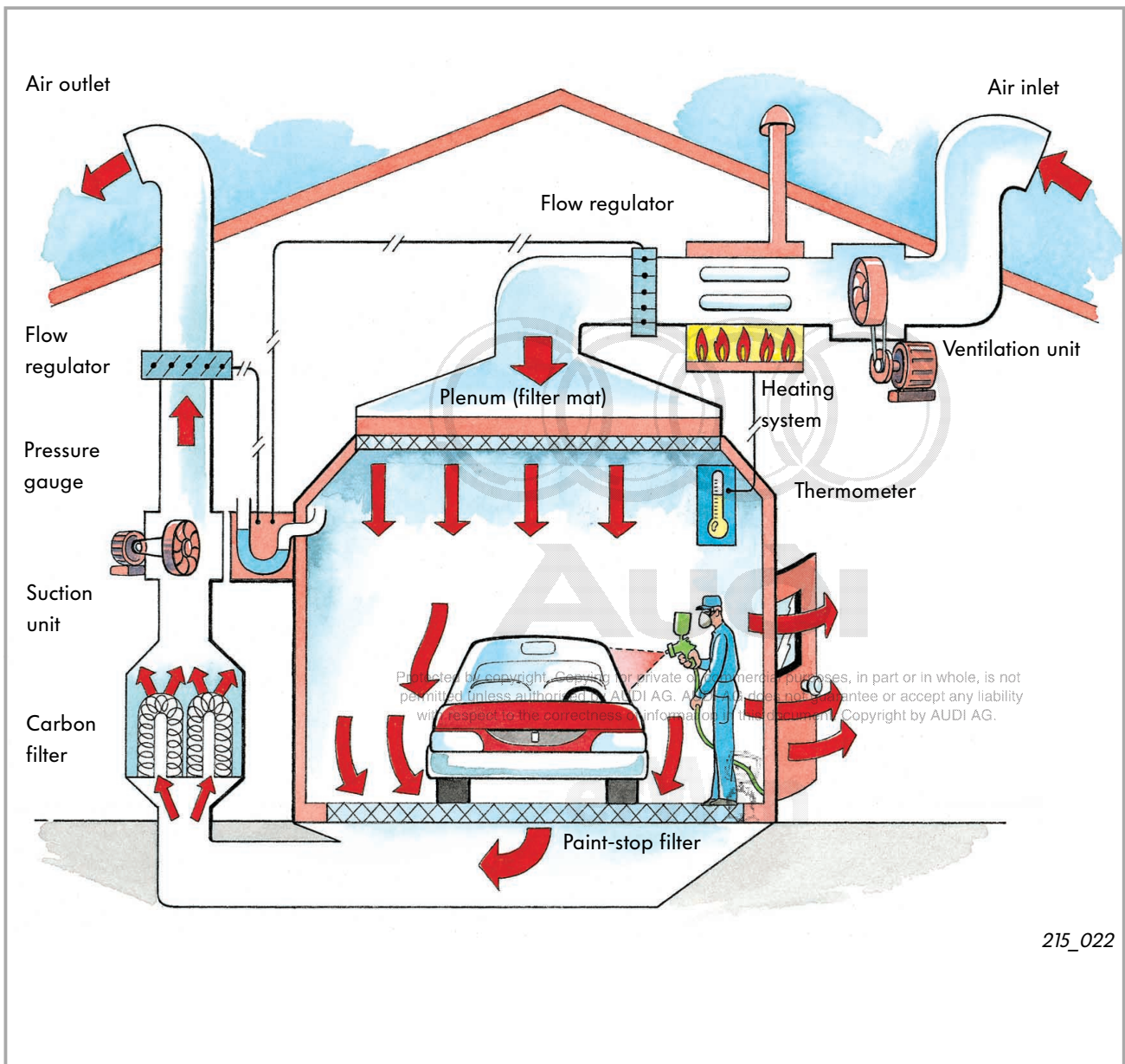

215\_022

Spray chamber

# Equipment, Auxiliary Tools

## Equipment for mixing the paint

A range of equipment is necessary to ensure the correct combination of colours and the proper mixture of thinner and hardener.

- Mixing bench
- Microfilm reader
- Precision scale
- Computer scale
- Measuring stick and similar tools

### Mixing bench

Various topcoat-paint containers are kept in the mixing bench.

Every container is provided with a special cover and stirring tool.

These are used to mix and dose the paint.

Paint tends to separate in storage.

It must therefore be stirred before use in order to yield a homogeneous mixture.

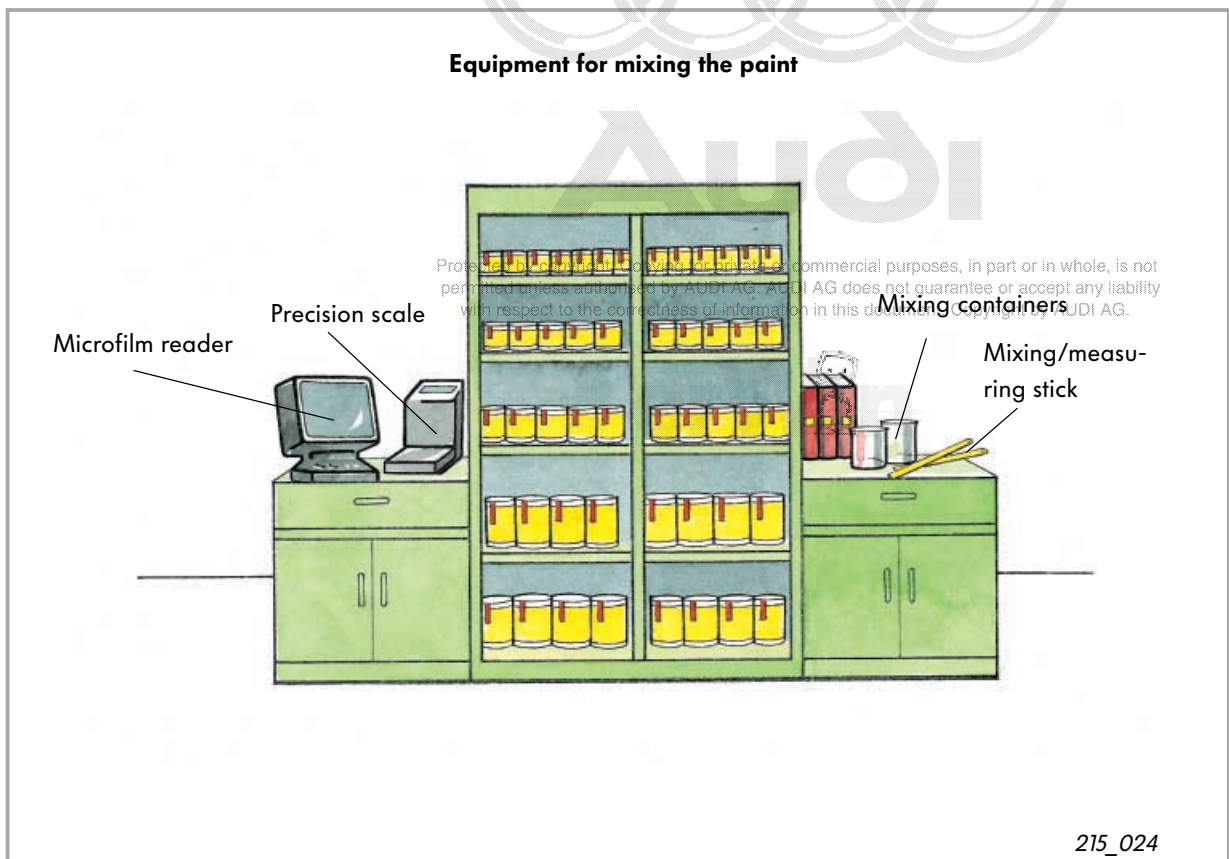

Mixing bench

## Microfilm reader

The microfilm reader, along with the microfilm and colour template, form the database containing all of the information on the composition of colours and colour mixtures.

## Precision scale

The precision scale is an essential tool for combining primary colours, because the amounts added must be exact.

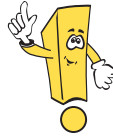

The new generation of **computer scales** provides additional information on paints, tables for mixing colours, as well as mixing problems and their solutions.

## Measuring and mixing stick

The materials to be added to the acrylic paint and primer extender can be easily measured and mixed with the aid of measuring and mixing sticks.

Any amount of paint can be mixed, depending on the manufacturer's specifications.

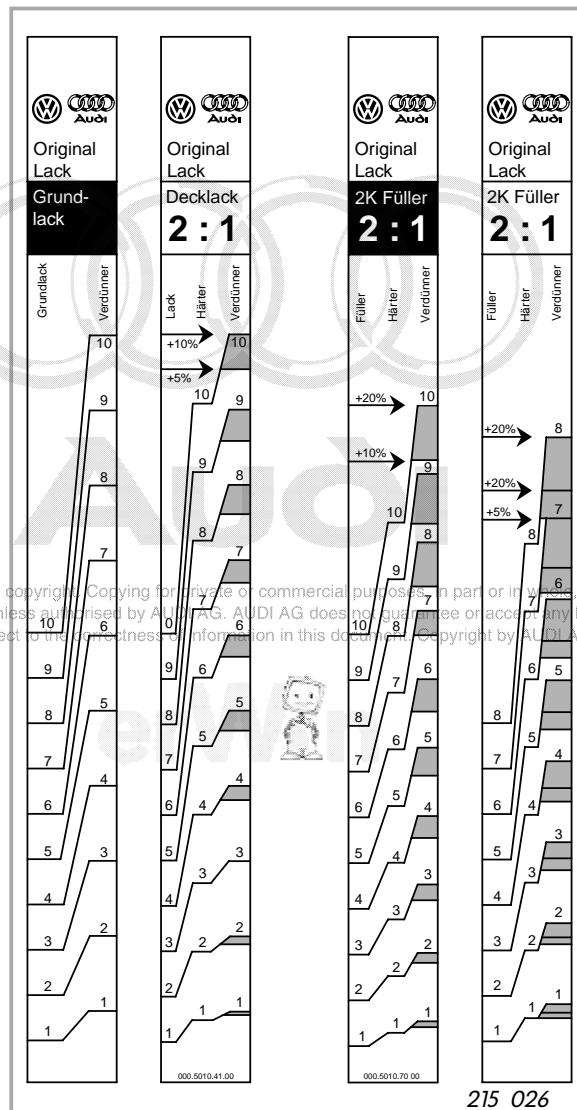

Measuring and mixing stick



# Equipment, Auxiliary Tools

## Beaker for measuring viscosity

The viscosity is checked with the aid of a viscosity-measuring beaker.

The viscosity-measuring beaker is a funnel-shaped container with a calibrated opening. The time it takes for the beaker to completely drain is measured. The longer the draining time, the higher the viscosity.

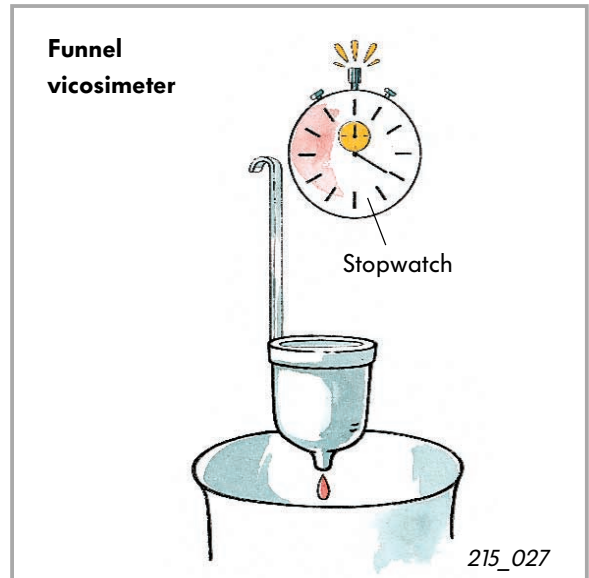

Viscosity-measuring beaker

## Paint filter

The mixed paint or primer must be inspected for foreign substances.

The suspended particles must be filtered using a paint filter, to prevent both clogging of the spray gun deposition of particles on the coat of paint.

Beaker and spray-gun filters are used to filter the particles.

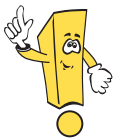

The correct filter must be used for each paint.

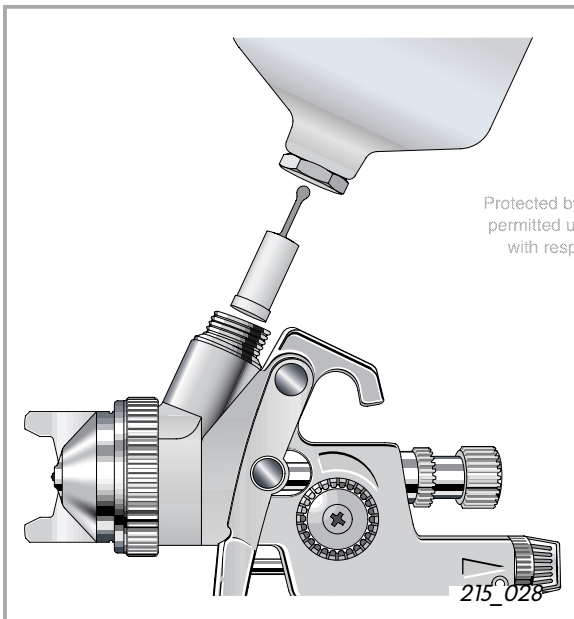

Spray-gun filter

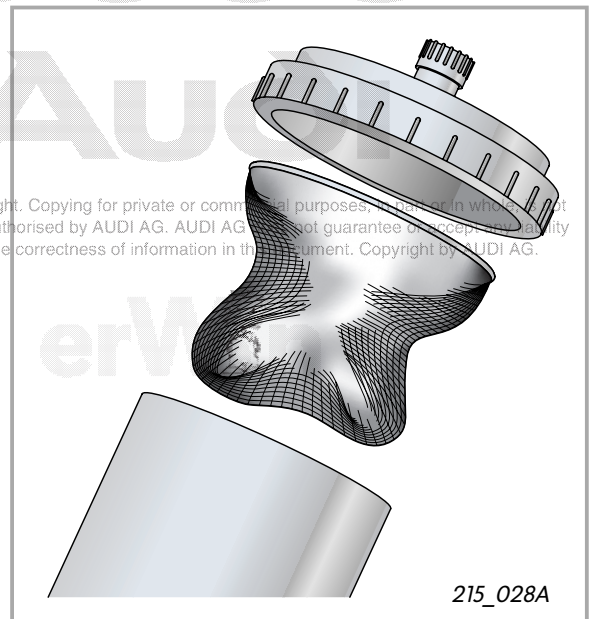

Beaker filter

## Tools and auxiliary devices

### Compressed-air gun

The compressed-air gun is connected to the workshop's compressed-air system. It removes most of the residue from the sanded surface.

A multi-nozzle is attached at the front. This special nozzle can triple the lag effect at a constant air intake.

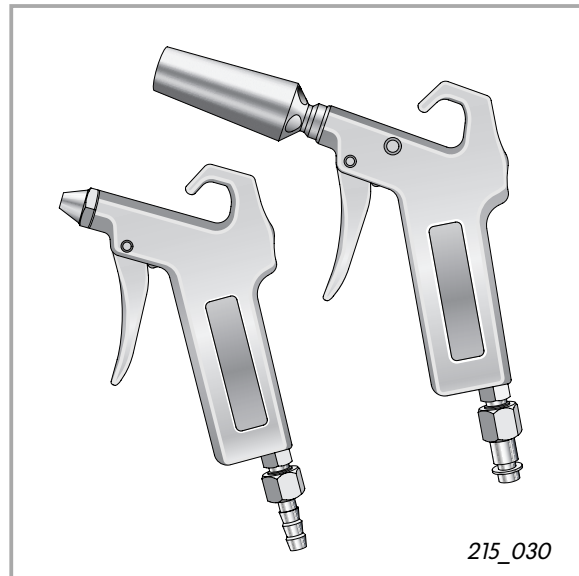

Compressed-air gun



### Impregnated dust cloth

The impregnated dust cloth picks up dust particles especially well because it is impregnated with resin. Cleaning with an impregnated dust cloth takes place directly before the application of the top coat.

### Spray-gun cleaning facilities

Spray guns, filler, containers and measuring sticks are cleaned with cleaning materials and solvents or universal cleaner.

The spray-gun cleaning facility consists of an air-tight chamber.

The tools and equipment to be cleaned are placed in this chamber.

When the cover is closed, a pneumatically driven pump distributes the solvent throughout the inside of the cleaning facility.

The pump shuts off automatically once the wash cycle is complete or the cover is opened.

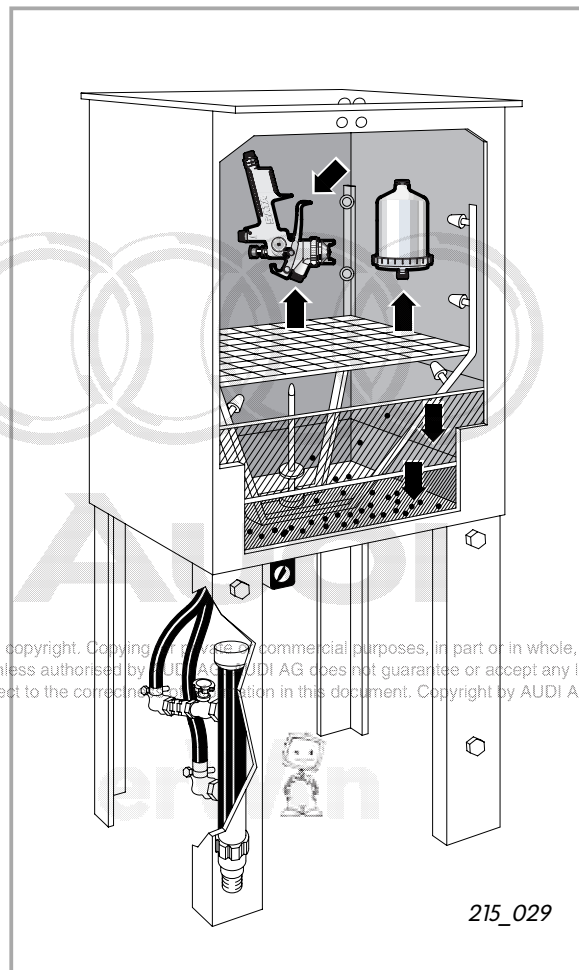

Spray-gun cleaning facilities

Protected by copyright. Copying for private or commercial purposes, in part or in whole, is not permitted unless authorised by AUDI AG. AUDI AG does not guarantee or accept any liability with respect to the correctness of the information in this document. Copyright by AUDI AG.

# Equipment, Auxiliary Tools

## Compressors

Since the paint is applied using compressed air, a workshop must be equipped with a compressor to supply enough pressure to maintain sufficient operational capacity.

The compressor must be equipped with a water and oil separator.

## Purification filter and regulating manometer

The compressed air for the spray and air-pressure gun must be free of solid particles, fats, oils and water.

Particles which are larger than 0.01 micrometer are caught and held back by the filter.

The air pressure is adjusted according to the material to be sprayed. Shut-off valves with manometers must therefore be provided in order to regulate the pressure.

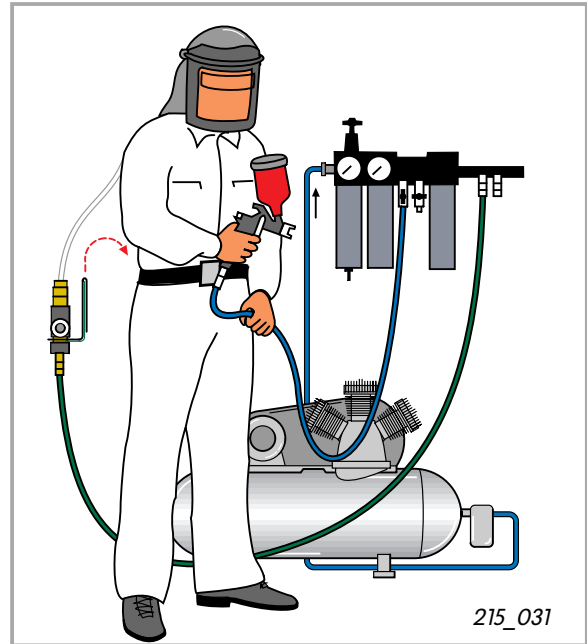

Compressor and filter unit

## Extender- and sanding-dust extraction systems

These systems are used for preparation, priming and sanding tasks.

The extraction system is located on the floor.

It extracts residue from the primer-sanding and even from the spray.

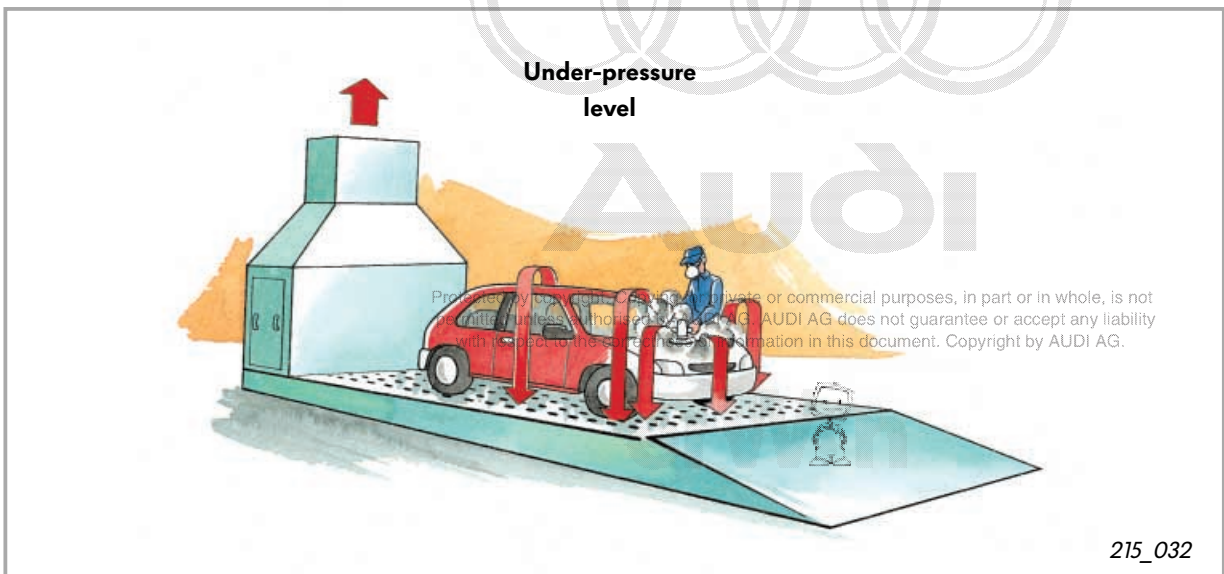

Extraction system

## Sanding tools

### Sandpaper

Sandpaper in the shape of discs and sheets is rarely used directly in the hand. The sandpaper is instead attached to a sander. Manual sanding tools are available as blocks and planes. They are used for small sanding jobs or touch-up work. Electrically or pneumatically driven sanding machines are also available.

Sanding disks and sanding sheets can be fastened to the tool in the following ways:

- Clamp fitting
- Slot-in
- Manual positioning
- Self-adhesive backside of sanding paper
- Velcro-fastening system

When using sanding machines that perform the sanding movement, the sandpaper must be securely attached to the sliding block. The self-adhesive and velcro-fastening systems are usually the best solution for these machines. The type of sliding block used with the sander depends upon the application.

- A **rigid** sliding block does not adjust to the surface but rather “marks” it. It is usually used on even surfaces.
- A **flexible** sliding block adjusts to the contours of the surface. It is used for the fine-surface work (such as sanding the primer before application of topcoat).

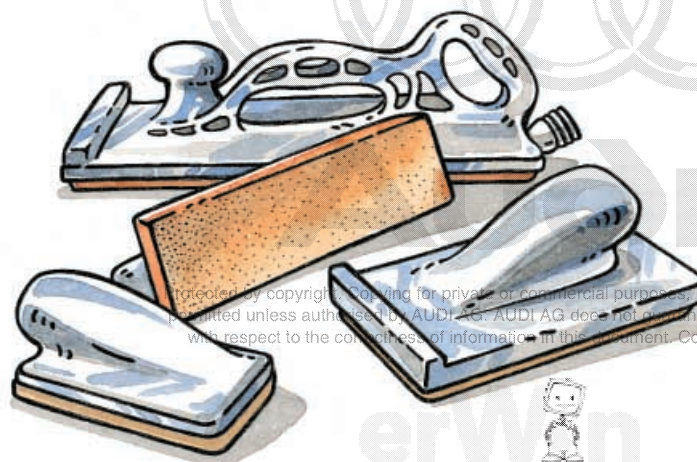

Protected by copyright. Copying for private or commercial purposes, in part or in whole, is not permitted unless authorized by AUDI AG. AUDI AG does not guarantee or accept any liability with respect to the correctness of information in this document. Copyright by AUDI AG.

215\_033

# Equipment, Auxiliary Tools

## Pneumatic and electric sanders

Sanding tools are either pneumatically or electrically driven.

Each type of drive has its advantages and disadvantages. For the majority of jobs, the pneumatic drive offers the most advantages.

Primary characteristics of sanding drives:

### Pneumatic sanders

- Adjustable operating speed
- Low weight
- Do not heat up during extended operation
- Compressed-air system required



### Electric sanders

- Non-adjustable operating speed
- Heavier
- Heat up during extended operation
- No special operating equipment necessary
- Safety regulations for electric devices must be observed

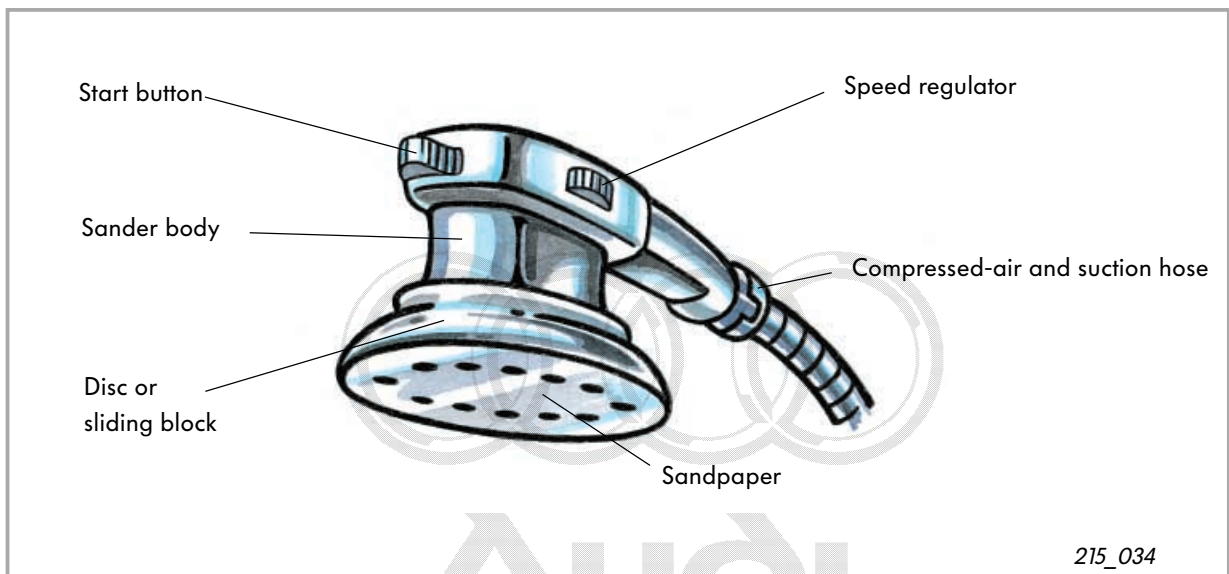

Pneumatic sander

Protected by copyright. Copying for private or commercial purposes, in part or in whole, is not permitted unless authorised by AUDI AG. AUDI AG does not guarantee or accept any liability with respect to the correctness of information in this document. Copyright by AUDI AG.



## Types of sanders

Sanders are classified according to their sanding motion.

### Orbital sander

The sand paper performs a rotating motion. The sliding block is round.

#### Advantage:

- Very aggressive sanding possible
- Ideal for difficult sanding jobs
- Fast sanding possible

#### Disadvantage:

- High heat development
- Difficult to use on even surfaces

#### Application:

- Removing old layers of paint
- Preparing panels for the application of filler
- Removing rust

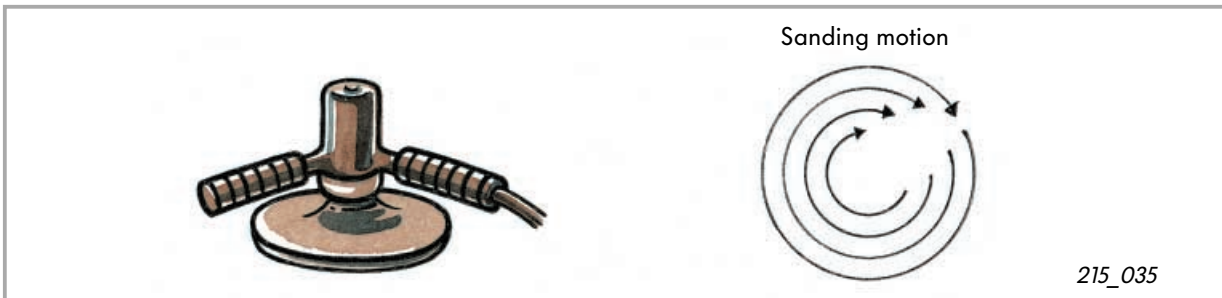

Orbital sander

### Vibrating sander

The sandpaper performs a vibrating motion. The sliding block is rectangular.

#### Advantage:

- Ideal for large, even areas
- Large sanding surface

#### Disadvantage:

- Cannot be used on rounded surfaces
- Vibrations, if the sliding block is not appropriately mounted
- Cannot be used with a flexible sliding block

#### Application:

- Sanding even surfaces
- Sanding polyester filler

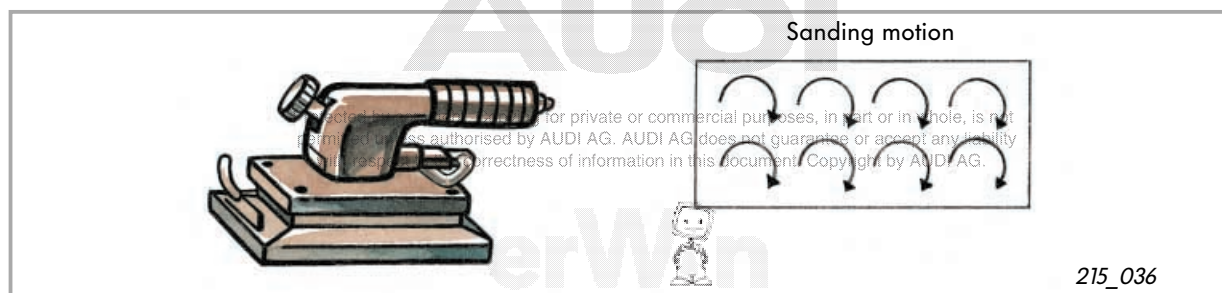

Vibrating sander

# Equipment, Auxiliary Tools

## Orbital vibrating sander

The sand paper performs a rotating-vibrating motion. The sliding block is round.

### Advantage:

- Good handling and high sanding power
- Minimal heat development

### Disadvantage:

- The sliding block must be guided flat to prevent the formation of sanding tracks
- Not appropriate for sanding filler on a flat surface

### Application:

- Sanding coats of paint
- Well-suited to the final preparation of the primer

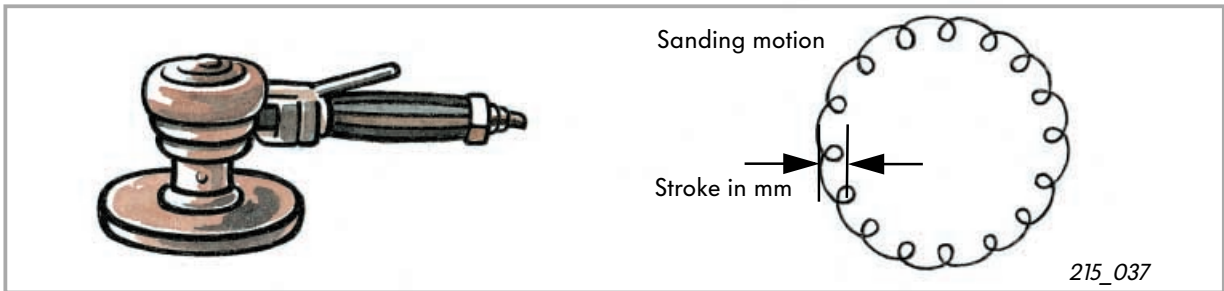

Orbital vibrating sander



The following should be observed:

For **coarse sanding**, such as filler, a machine with a 5-10 mm stroke should be employed.

For fine sanding or sanded old paint, a device with a 3-5 mm stroke is employed.

For more detailed information on sanding, please refer to the **Basic Principles** chapter of Self-Study Programme 214, "Painting the Vehicle - Pre-Treatment".

Protected by copyright. Copying for private or commercial purposes, in part or in whole, is not permitted unless authorised by AUDI AG. AUDI AG does not guarantee or accept any liability with respect to the correctness of information in this document. Copyright by AUDI AG.



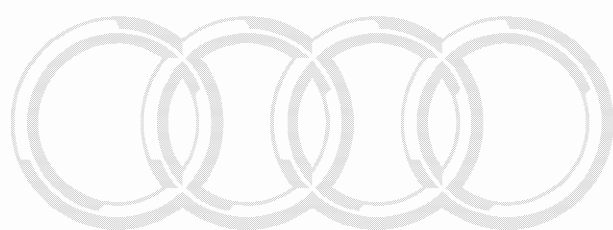

# Audi

Protected by copyright. Copying for private or commercial purposes, in part or in whole, is not permitted unless authorised by AUDI AG. AUDI AG does not guarantee or accept any liability with respect to the correctness of information in this document. Copyright by AUDI AG.



# Application of the Topcoat

## Mixing and applying the topcoat

For the optimal application of the topcoat, all of the parameters which can influence the process should be taken into account: hardener, thinner, processing temperature, adjustment and motion of the spray gun.

### Mixing single-coat paint

A single-coat paint is mixed by adding hardener and thinner in a precise ratio.

The ambient temperature is an important factor in the mixing process.

The optimal processing temperature is between 18 °C and 25 °C.

### Mixing two-coat paint

#### ● Two-layer base

The two-layer base is made of one component. Only thinner needs be added in order to adjust the viscosity.

Various thinners may be used, depending on the temperature.

#### ● Clear lacquer

For two-coat paint, clear lacquers with various qualities can be used as a topcoat. Hardener and thinner must be added to the lacquer - same as with the one-coat paint.

### Mixing single-coat paint

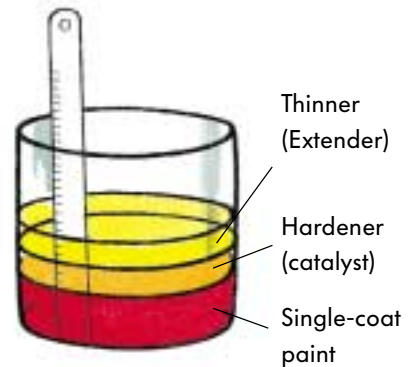

### Mixing two-coat paint

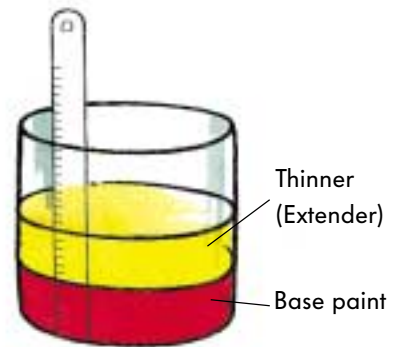

### Mixing clear lacquer

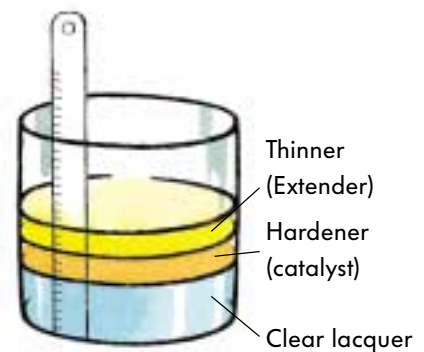

215\_038

Mixing

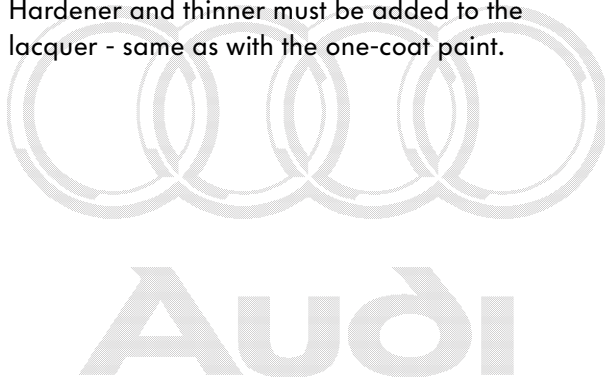

Protected by copyright. Copying for private or commercial purposes, in part or in whole, is not permitted unless authorised by AUDI AG. AUDI AG does not guarantee or accept any liability with respect to the correctness of information in this document. Copyright by AUDI AG.



## Processing with the spray gun

Producing a good topcoat without any application marks depends on many factors. These include:

- Composition of the paint
- Thinner
- Ambient temperature
- Composition of the part that is to be sprayed
- Evaporation of the solvents

### Evaporation of the solvents (volatile bonding agents)

The evaporation speed of the solvent is decisive in the formation of the paint coat.

If the solvent evaporates too quickly, the coat of paint will not extend sufficiently. A wrinkled surface forms.



Orange peel

If the solvent evaporates too slowly, the paint will separate. The result is the formation of drops or cracks.

The evaporation curve of the processing temperature can be adjusted by mixing in the correct amount of thinner (extender). Various thinners are available for application at various temperatures.

At higher processing temperatures, the thinner slows down the process of evaporation. At lower processing temperatures, the thinner accelerates the evaporation process.

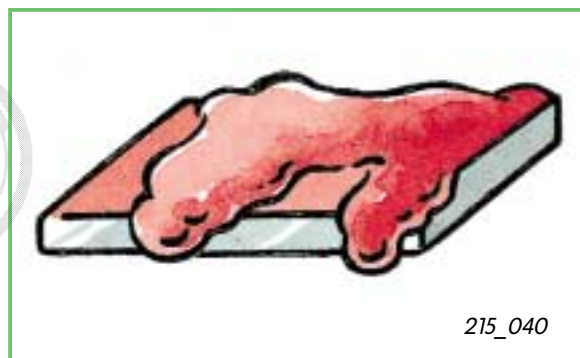

Formation of drops and runs

Protected by copyright. Copying for private or commercial purposes, in part or in whole, is not permitted unless authorised by AUDI AG. AUDI AG does not guarantee or accept any liability with respect to the correctness of information in this document. Copyright by AUDI AG.



# Application of the Topcoat

## Surface, coat of paint

The injection pressure and the diameter of the nozzle opening determine the flow of paint as well as the amount of solvent which evaporates before reaching the part to be painted.

## Spraying distance

The optimal working distance depends upon the type of paint, its viscosity and the spray gun. The spraying distance is normally between 15 and 20 centimetres. The greater the distance, the more the solvent evaporates, and as a result the paint spreads poorly (orange peel). The smaller the distance, the higher the concentration of paint and proportion of solvent, causing "runs" to form.

## Humidity

A relative humidity of 80% slows down the process of solvent evaporation. Very low humidity - under 20% - speeds up the process of evaporation. Both conditions can lead to a poor drying result.

Protected by copyright. Copying for private or commercial purposes, in part or in whole, is not permitted unless authorised by AUDI AG. AUDI AG does not guarantee or accept any liability with respect to the correctness of information in this document. Copyright by AUDI AG.

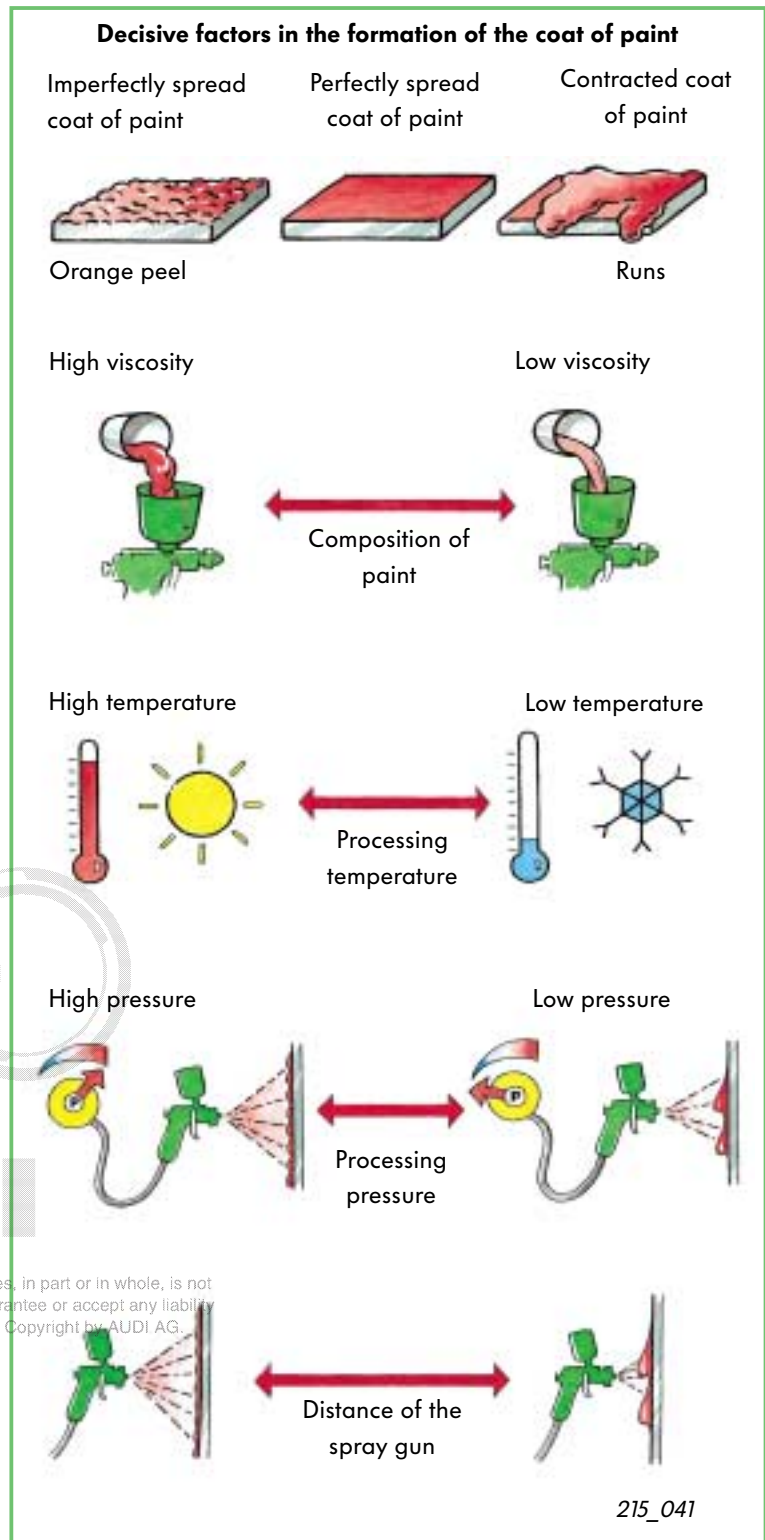

Factors which influence the coat of paint



## Basic requirements

To produce a high quality paint job, the spraying process must satisfy certain basic requirements.

- Mix the paint according to the instructions on the datasheet (manual).
- Monitor the ambient temperature and decide what sort of hardener or thinner should be used.
- Maintain the spraying distance. The spray gun must always be held vertically to the area that is to be painted (see following chapter).
- For an even coating, guide the spray gun evenly.
- Do not pull back the spray gun trigger until the gun is set in motion. Release the trigger while the gun is still in motion.
- The distance between strokes should not be too large. Each pass must cover half of the previous pass.

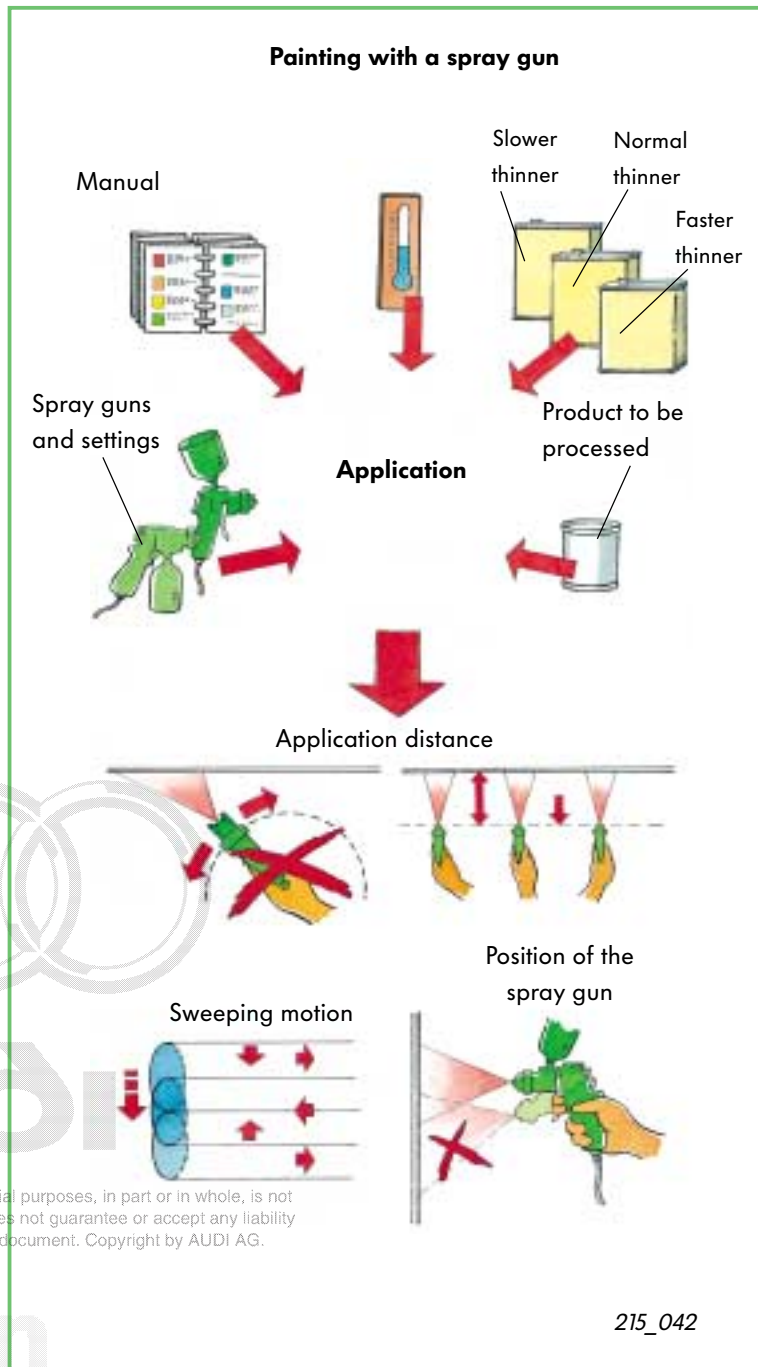

Protected by copyright. Copying for private or commercial purposes, in part or in whole, is not permitted unless authorised by AUDI AG. AUDI AG does not guarantee or accept any liability with respect to the correctness of information in this document. Copyright by AUDI AG.

Basic requirements



# Application of the Topcoat

## Spray guns

An absolutely even coating thickness with a smooth paint surface can be achieved with the aid of a spray gun.

The spray gun is the most important tool for any paint job.

Regular maintenance, complete cleaning after every use and careful handling of all the parts of a spray gun are essential for a high-quality topcoat.

### How the spray gun works

Through the supply of a compressed stream of air and the design of the spray gun, the paint is entrained (Venturi principle) and then released from the nozzle.

If the paint container is attached over the spray gun, it is called a **jet pistol**, and if it is attached under the spray gun it is called a **suction pistol**.

When you pull back the trigger to the first pressure point, only the compressed air valve opens.

If you pull it back further, the nozzle needle shifts, and the paint shoots out from the air stream at a high speed.

The mist, made up of micro drops, is formed by this process.

The air pressure determines the size of the droplets:

High pressure = small droplets

Low pressure = large droplets

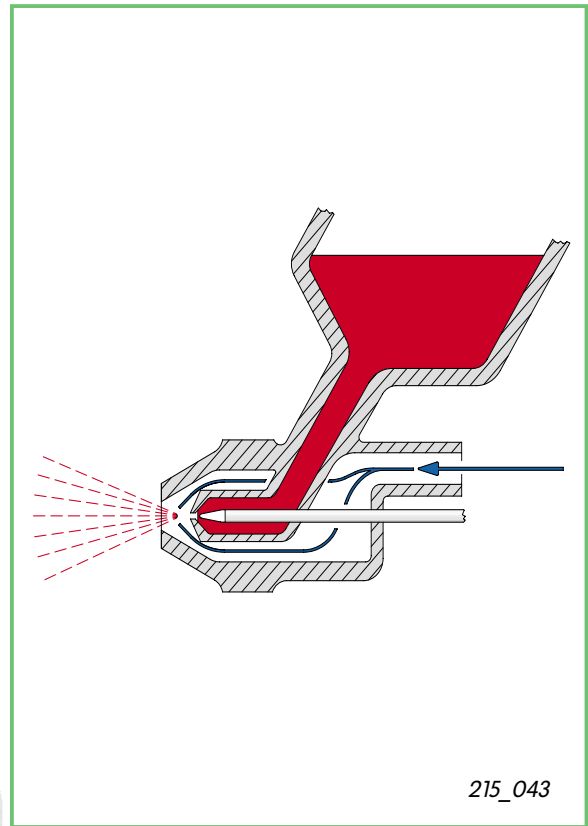

Jet pistol

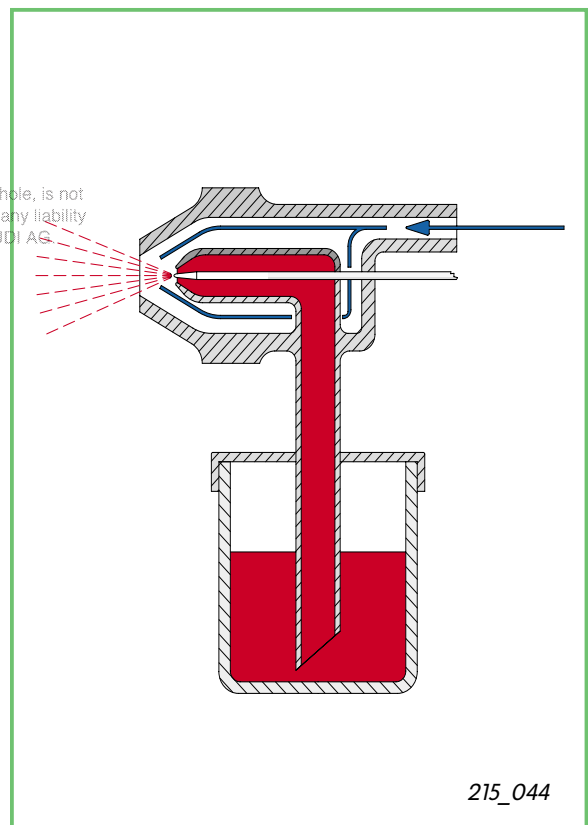

Suction pistol



## Cross section of a jet pistol

The correct nozzle must be chosen for the application of the different types of paints .

Greater paint viscosity requires a larger nozzle diameter.

The point at which the paint and air emerge from the nozzle is called the "hot spot".

The size of the nozzle is specified in millimetres.

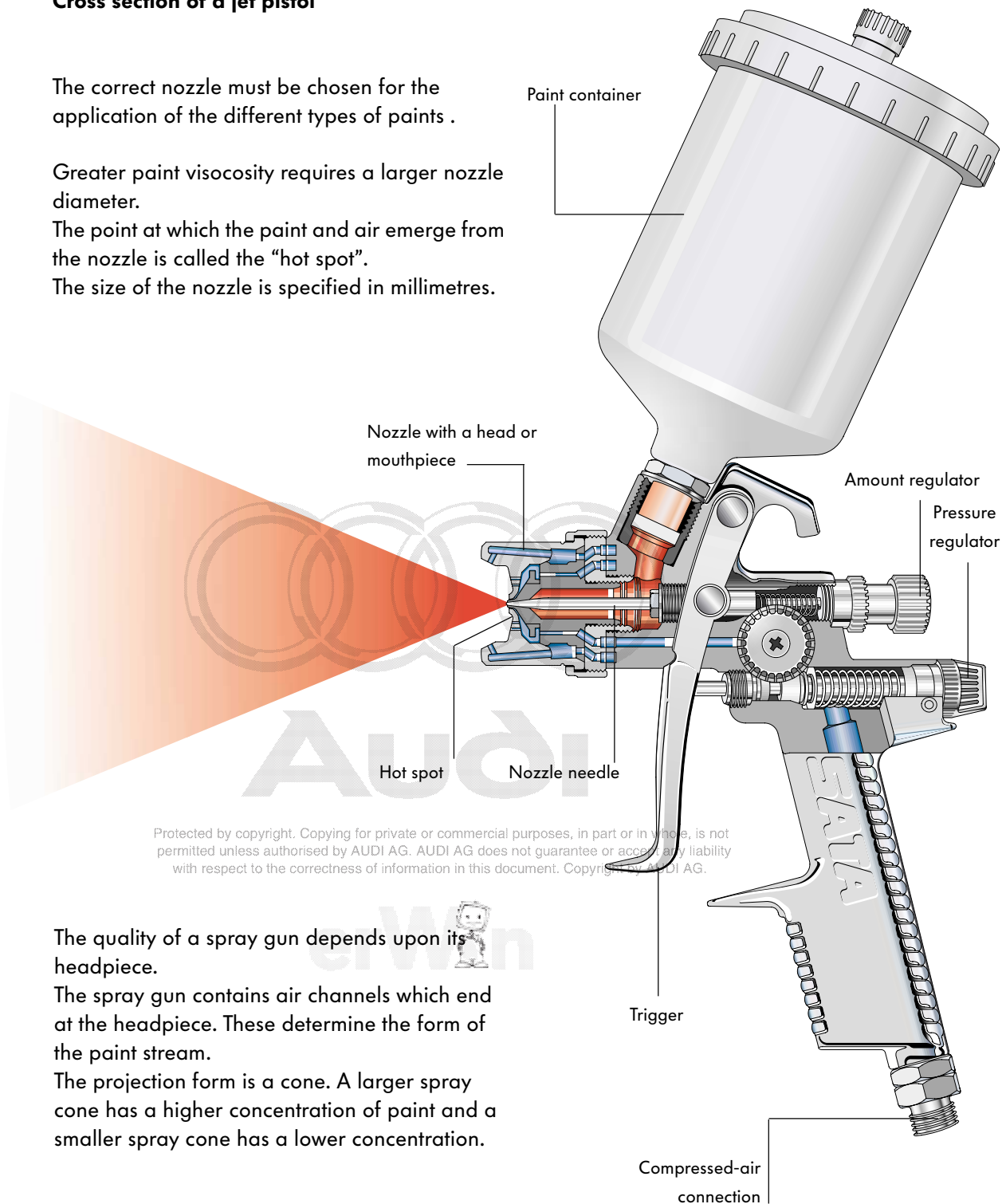

Protected by copyright. Copying for private or commercial purposes, in part or in whole, is not permitted unless authorised by AUDI AG. AUDI AG does not guarantee or accept any liability with respect to the correctness of information in this document. Copyright by AUDI AG.

The quality of a spray gun depends upon its headpiece.

The spray gun contains air channels which end at the headpiece. These determine the form of the paint stream.

The projection form is a cone. A larger spray cone has a higher concentration of paint and a smaller spray cone has a lower concentration.

215\_045

# Application of the Topcoat

## Adjusting the spray gun

The spray gun must be adjusted to give the spray cone the optimal size and shape.

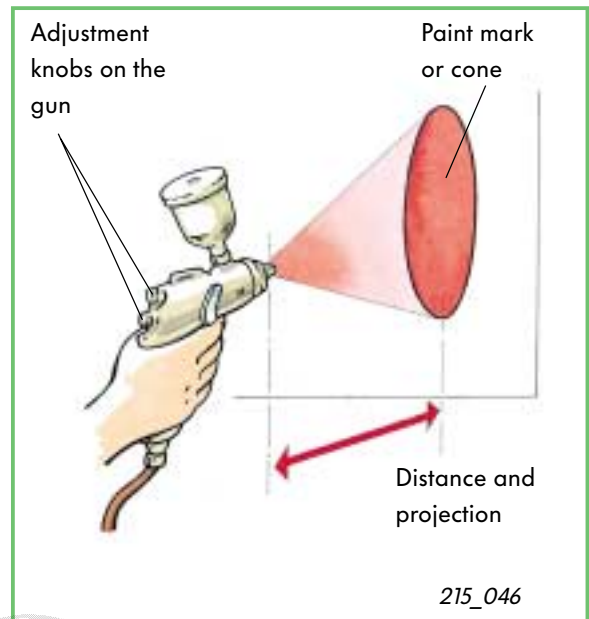

Spray cone

- The spray regulator can progressively adjust the stream from a circular-section jet to fan jet.
- The flow-rate adjustment knob regulates the amount of paint applied. A sample spray on a carton or piece of sheet metal - from the correct distance - is the simplest way to check the spray gun settings.
- The air-flow knob adjusts the air pressure. The working pressure is chosen based on the material and technical specifications. For conventional spray guns, the working pressure is between 3 and 5 bars. The adjustment knob can also be used to adjust the shape of the cone.

Protected by copyright. Copying for private or commercial purposes, in part or in whole, is not permitted unless authorised by AUDI AG. AUDI AG does not guarantee or accept any liability with respect to the correctness of information in this document. Copyright by AUDI AG.

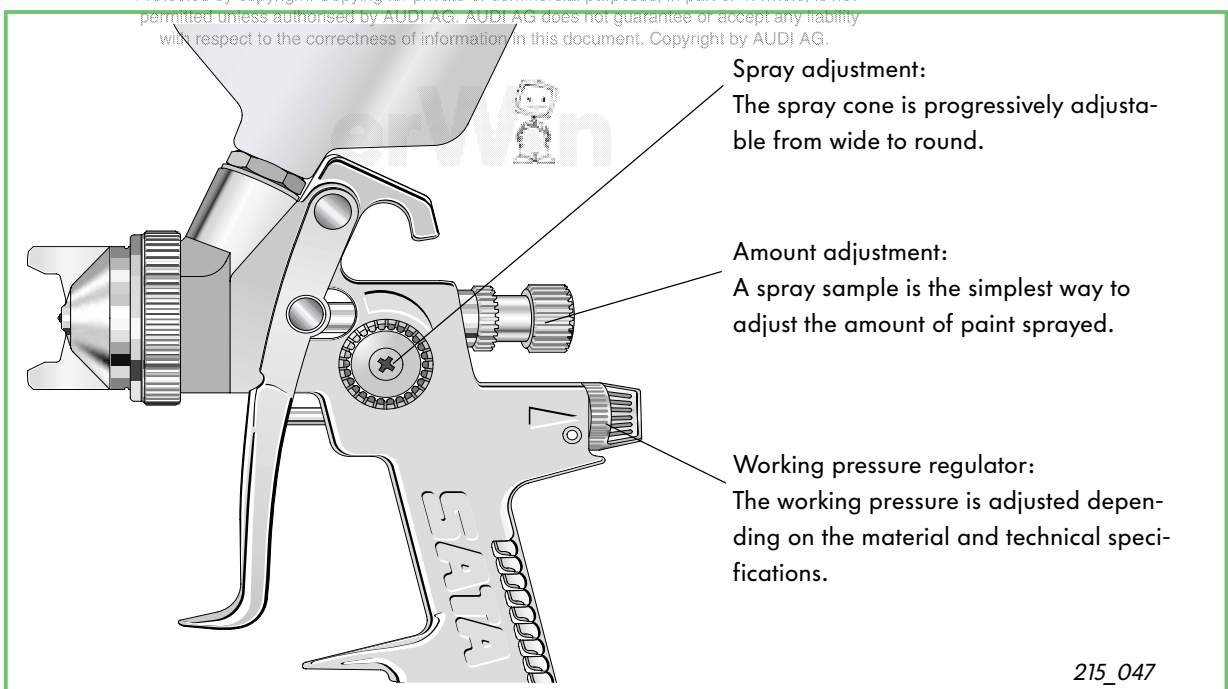

Adjusting the spray gun

## Spraying the paint

The distance between the piece to be painted and the spray gun must remain constant.

The speed at which the spray gun is guided must also be even and constant.

## HLVP spray guns

The HLVP spray gun (high volume, low pressure) can apply paint at a very low working pressure. The projection cone (paint-air mixture) can be adjusted to make better use of the paint at a lower pressure.

The result is that less paint goes beyond the part that is to be painted.

Using an HLVP spray gun reduces the overall amount of paint consumed.

At the same time, less solvent evaporates into the atmosphere.

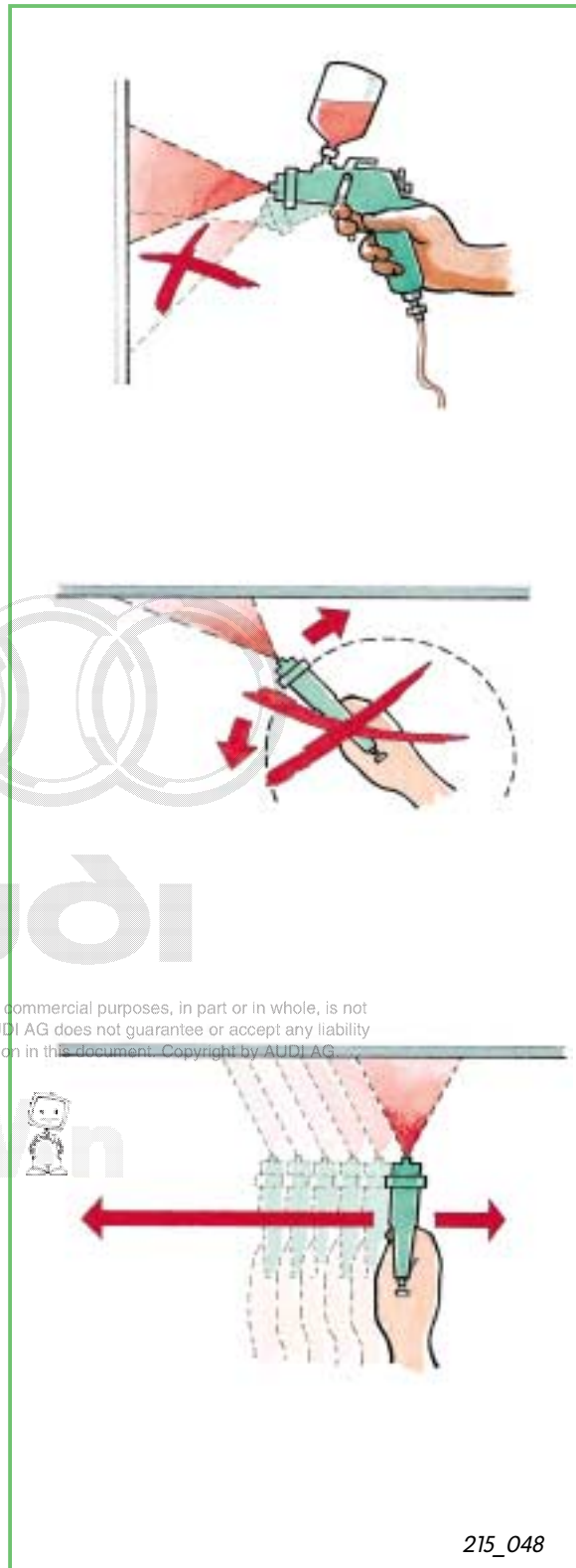

Spraying the paint



# Application of the Topcoat

## Drying

For fast drying and hardening of paint, the workshop must possess the appropriate facilities and devices.

### Spray/drying cabins

The spray/drying cabin is a combination of a spray cabin and drying chamber (see page 23). In the drying chamber, the air can be warmed to up to approximately 60 °C. This temperature accelerates the chemical reaction as well as the evaporation of the solvent and thinner (extender) contained in the paint.

The temperature may only be increased in stages. These stages are automatically controlled by the drying chamber.

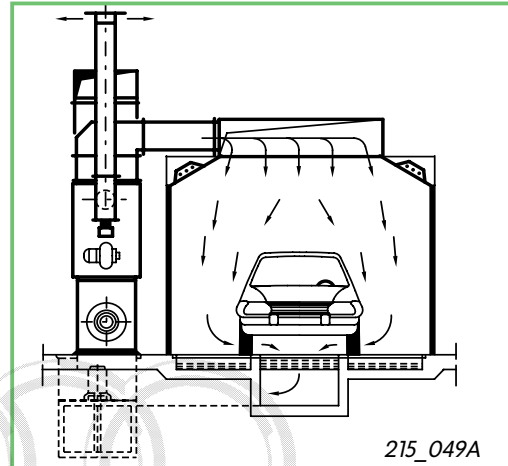

Combination spray/drying cabin with water filter

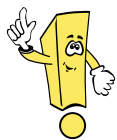

If the drying temperature rises too fast, the result may be the formation of bubbles.

Protected by copyright. Copying for private or commercial purposes, in part or in whole, is not permitted unless authorised by AUDI AG. AUDI AG does not guarantee or accept any liability with respect to the correctness of information in this document. Copyright by AUDI AG.



### Cause of bubble formation

When temperatures rise too quickly, the paint surface dries up first (skin formation). Solvent cannot evaporate from the paint coat into the atmosphere. The result is the formation of bubbles.

After the application of the top coat, a drying time of 10 minutes must be observed to allow the volatile solvents to evaporate.

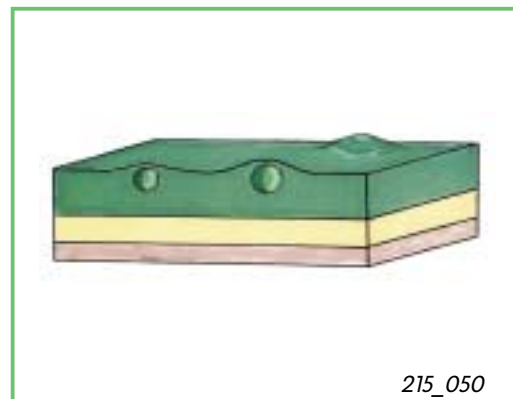

215\_050

Bubble formation

## Infrared drier

In an infrared drier, thermal radiation - as opposed to the thermal conduction (convection) of a drying chamber - is responsible for the drying process.

Only after the underlying panel has become warm does the warmth carry over to the coat of paint.

### Advantage:

The drying process starts from within and continues outwards.

The drying time is shorter than with the warm-air system.

The following must be observed:

- The ventilation time of the paint before the infrared drier is turned on
- The distance between the infrared drier and the surface

- The duration of the radiation  
The infrared drier is most commonly used for drying filler and primer. The time between steps is shortened without having to use the spray/drying cabin.  
The spray/drying cabin can be used exclusively for the application and drying of the topcoat (see graphic Page 20).

### Infrared drier radiation

There are two types of infrared driers:

- Infrared drier with short-wave radiation
- Infrared drier with medium-wave radiation

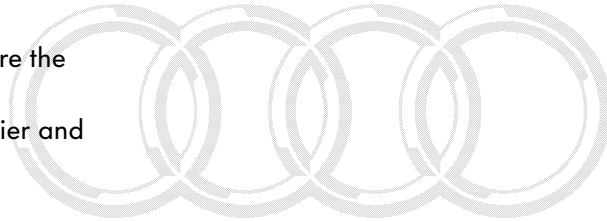

# Audi

Protected by copyright. Copying for private or commercial purposes, in part or in whole, is not permitted unless authorised by AUDI AG. AUDI AG does not guarantee or accept any liability with respect to the correctness of information in this document. Copyright by AUDI AG.

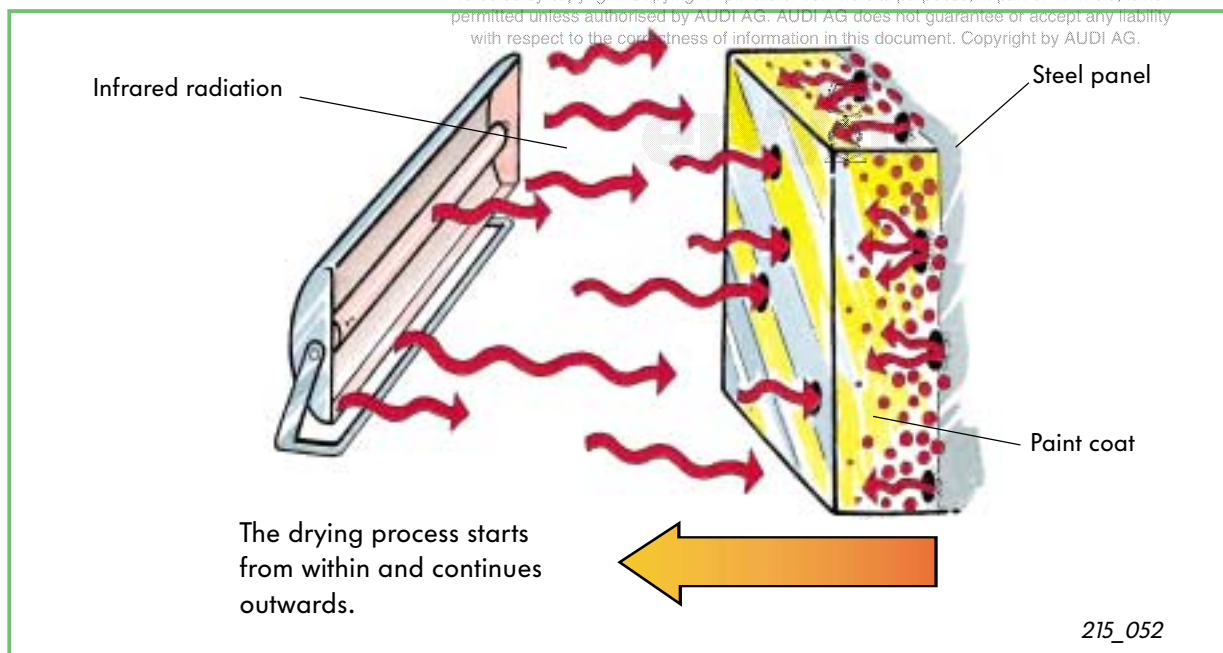

Thermal radiation

# Application of the Topcoat

The **short-wave** devices generate radiation by means of quartz tubes. They emit rays which lie within the field of vision (a red/orange-coloured light).

The working temperature is reached within seconds, and the cooling follows quickly. The drying time is short because the rays are intense.

The **medium-waves** devices generate the rays by means of ceramic plates. They emit rays which lie outside the field of vision. They give off heat when in operation.

The working temperature is reached after a few minutes, the cooling process also takes some time.

The drying time is longer than with the short-wave devices.

| Drying times-infrared drier<br>(Example at 80cm distance) |                 |
|-----------------------------------------------------------|-----------------|
| Material                                                  | Drying time     |
| Polyester filler                                          | 2 minutes       |
| Spray filler                                              | 2 to 7 minutes  |
| Water-based primer extender                               | 7 to 9 minutes  |
| Primer                                                    | 3 to 8 minutes  |
| Topcoat                                                   | 7 to 10 minutes |



## Warm-air drier

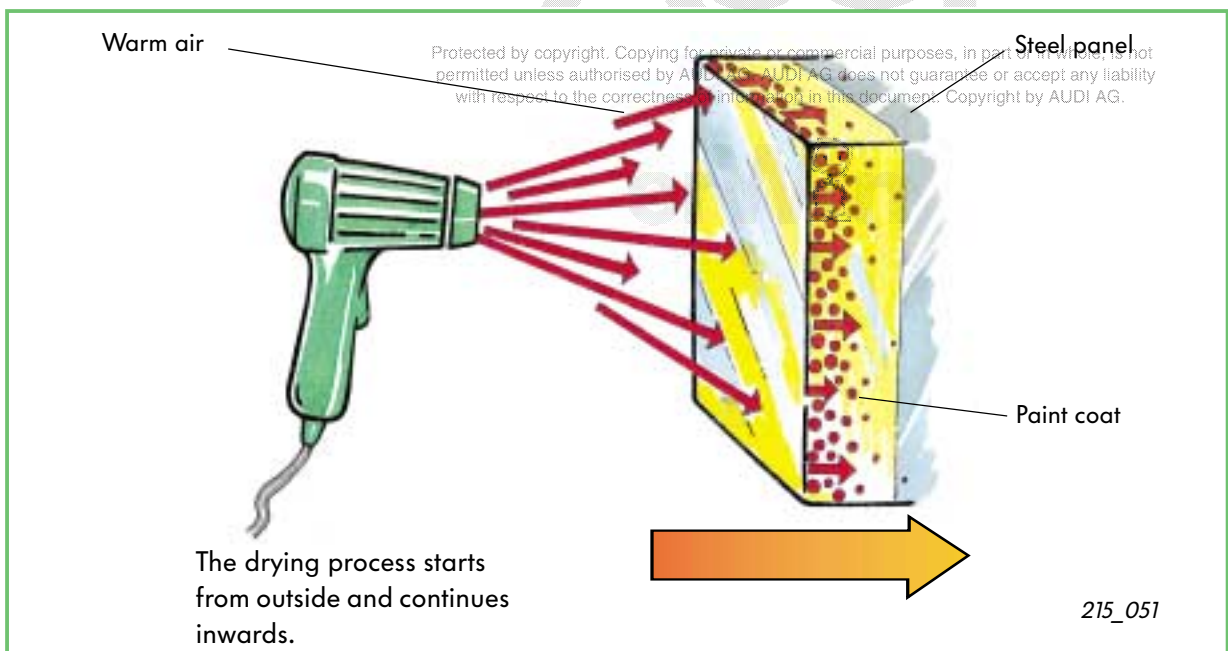

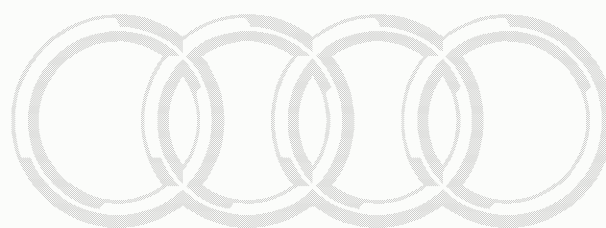

# Audi

Protected by copyright. Copying for private or commercial purposes, in part or in whole, is not permitted unless authorised by AUDI AG. AUDI AG does not guarantee or accept any liability with respect to the correctness of information in this document. Copyright by AUDI AG.

erWin 

# Check Your Knowledge

---

## 1.) What is light?

- A  Electromagnetic rays with wavelengths between 400 and 700 nanometers.
- B  Electromagnetic rays with wavelengths between 100 and 300 nanometers.
- C  The visible spectrum of electromagnetic radiation.

## 2.) When does an object appear yellow to the human eye?

- A  When the object absorbs red radiation and reflects green and blue.
- B  When the object absorbs blue radiation and reflects red and green.
- C  When the object absorbs green radiation and reflects blue and red.

## 3.) What does metamerism mean?

- A  Two objects viewed under the same source of light have the same colour, and viewed under a different source of light have different colours.
- B  Two objects have different colours viewed under each source of light.
- C  Two objects have the same colour viewed under each source of light.

## 4.) What is the Ostwald-chromatic circle?

- A  The representation of the primary pigment colours and their mixtures in a pigment-chromatic circle.
- B  The representation of all the colours that can be mixed from red, yellow and blue.
- C  The representation of all of the colours that can be mixed from secondary colours.

Protected by copyright. Copying for private or commercial purposes, in part or in whole, is not permitted unless authorised by AUDI AG. AUDI AG does not guarantee or accept any liability with respect to the correctness of information in this document. Copyright by AUDI AG.



---

**5.) How can the colour of a sample spray deviate from that of the vehicle?**

- A  Tone
- B  Degree of shine
- C  Purity
- D  Brightness

**6.) Which types of topcoat paints are most commonly used?**

- A  One-layer topcoat
- B  Two-layer topcoat
- C  Three-layer topcoat

**7.) Covering pigments may consist of which materials?**

- A  Mineral/organic substances
- B  Aluminium platelets
- C  Synthetic core with an enamel coat
- D  Synthetic material with a layer of oxide

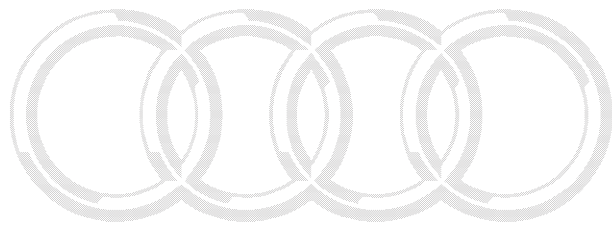

**8.) What volume of air must be blown into a spray chamber?**

- A  The same volume as drawn out of the spray chamber
- B  A smaller volume than drawn out of the spray chamber
- C  A larger volume than drawn out of the spray chamber

Protected by copyright. Copying for private or commercial purposes, in part or in whole, is not permitted without the prior written consent of AUDI AG. AUDI AG does not guarantee or accept any liability with respect to the correctness of information in this document. Copyright by AUDI AG.



# Check Your Knowledge

---

9.) What information does the new generation of computer scales provide?

- A  Information about paints
- B  Information about colour-mixing tables
- C  Information about mixing problems
- D  Information about painting equipment

10.) What does a viscosity beaker measure?

- A  The volume of the paint
- B  The thickness of the paint
- C  The density of the paint

11.) Which of the following describes the compressed-air properties required by a spray gun?

- A  It must be free of solid particles and water
- B  Highly compressed
- C  Free of fats and oils
- D  Pre-heated

12.) Which sliding block is best suited to finish-sanding a coat of paint?

- A  Flexible sliding block
- B  Rigid sliding block
- C  Rectangular sliding block

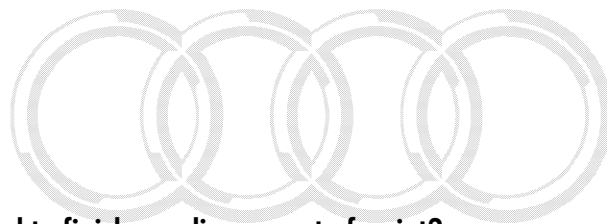

Audi

Protected by copyright. Copying for private or commercial purposes, in part or in whole, is not permitted unless authorised by AUDI AG. AUDI AG does not guarantee or accept any liability with respect to the correctness of information in this document. Copyright by AUDI AG.

erWin 



---

**13.) The vibrating sander with a rectangular sliding block is best suited to which application?**

- A  Removing old layers of paint
- B  Removing rust
- C  Sanding even surfaces
- D  Sanding polyester filler

**14.) Which factors are decisive in the formation of a paint coat?**

- A  Spraying pressure
- B  Spraying distance
- C  Composition of the paint
- D  Humidity

**15.) Which rules must be observed when painting with a spray gun?**

- A  The spraying distance must be maintained
- B  The spray gun must always be guided at an even and constant speed
- C  The cone must be as small as possible
- D  The spray gun must be vertical to the surface

**16.) What advantages does an HLVP spray gun offer?**

- A  Better utilisation of the paint
- B  Shorter painting time
- C  Lower consumption of paint
- D  Less evaporation of the solvent into the atmosphere

Protected by copyright. Copying for private or commercial purposes, in part or in whole, is not permitted unless authorised by AUDI AG. AUDI AG does not guarantee or accept any liability with respect to the correctness of information in this document. Copyright by AUDI AG.

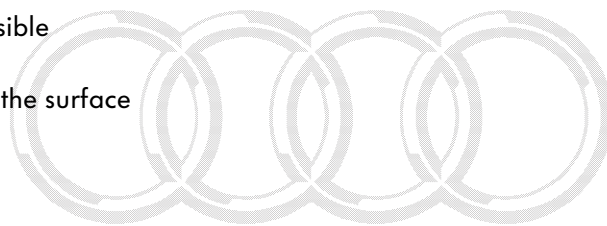

Audi

erWin 



# Glossary

---

## Absorb

To absorb; to occupy completely

## Absorption

1) Physics: The partial or complete absorption of electromagnetic waves or particle radiation while passing through matter. The energy of the absorbed rays is converted to heat (absorption heat).

2) Chemistry: The absorption of gases and vapours through liquids or solid bodies and the even distribution within the absorbing substance.

3) Biology: The absorption of liquids, vapours, etc. via the cells.

## Acrylic

Synthetic material made of polyacrylonitrile

## Chromo

Modifier with the meaning ›colour‹, ›pigment‹

## Cyanide

Salts from hydrogen cyanide; very poisonous; technically important intermediate products

## Chromatics

Science of colours as an optical phenomenon (perception), as colour-causing agent (paint), colour, pigment, as variegation (in their entirety to achromatic = white, grey, black), as electromagnetic radiation (light with specific wavelengths). A sensation of a colour in general occurs through the reaction of visible light (wavelength range 400-700 nm) on the eye's colour-sensitive retinal cones.

The manifestation of colours are the colourful lights (primary source of light) and the body colours (non-primary sources of light). The tone is the characteristic of all variegated colours. The greater or less strength of the emergence of the tone in a variegated colour determines the saturation. Every colour has a luminosity. Each colour can be clearly described with the aid of these three characteristics.

In a colour system, a legally-determined selection made from the range of possible colours, which are colorimetrically defined, is perceived by the viewer in equal increments across the spectrum. The DIN colour system uses as a certification of the colours: tone (T), chroma/saturation (scale) (S) and blackness value (D); a colour is also labelled using the colour symbols T:S:D e.g. 3:6:2.

The colour measurement serves as a determination of the 3 colorimetricals which indicate a colour stimulus specification. These numbers are in general specific to a certain colour temperature.

## Colourants

Mostly organic compounds, which can colour other materials so that they are more or less wash-resistant. One differentiates between natural colourants, such as carmine, purple, indigo, and artificial (synthetic) colourants. Those groups responsible for colours in their molecules are called chromophore groups (chromophores), through these, colourless compounds become colourants (chromogens); groups with characteristics of an acid have a colour strengthening effect (these are called auxochromes groups or auxochromes).

## Fluoresce

To illuminate (material) by means of radiation (such as light)

## Catalyst

1) Chemistry: Substance which even in slight amounts changes the speed of a chemical reaction (catalyse), usually accelerating, without itself being used up. Important catalysts include vanadium oxide, platinum, peroxide, active coal, metalorganic complex compounds and ion exchangers.

2) Technical: Catalytic converter

## Complementary colours

(Supplementary colours), colour stimulus specifications which become white with additive mixtures, and with subtractive mixtures become very dark, almost black; examples included yellow and blue, cyan and red, purple and green.

## Magenta

In the printing industry, the designation for the primary colour purple, aniline red

## Metamerism

Property of spectrally different chromatic stimuli, which trigger the same colour perception.

## Nanometer

One thousand millionth of a meter, symbol: nm

## Newton

Protected by copyright. Copying for private or non-commercial purposes, in part or in whole, is not permitted unless authorised by AUDI AG. AUDI AG does not guarantee or accept any liability with respect to the correctness of information in this document. Copyright by AUDI AG.

Eighteenth century English mathematician, physicist and astronomer.



### *Ostwald*

Ostwald, Wilhelm, \*)Riga 2.9. 1853, †)Großbothen near Grimma 4.4. 1932, German chemist and philosopher

### *Phenomenon*

- 1) Philosophy: Appearance
- 2) General: Exceptional occurrence, event; person with exceptional talents

### *Polyurethane*

Synthetic material, multi-purpose

### *Receptors*

The sensation faculties of a living cell (or organ) for the reception of certain stimuli. According to type of adequate stimuli one differentiates among chemo-, osmo-, thermo-, mechano-, photo-, phono- receptors, according to the location in the organism, extero receptors (on the body's periphery; for the reception of exterior stimulation) and internal receptors (within the body).

### *Receptor*

(mostly plural) Ends of nerve fibre or specialised cells in the skin and in the internal organs for the reception of stimuli.

### *Spectral colours*

The unmixed, pure colours of a spectral breakdown of the light (7 main colours of varying wavelength, which can no longer be broken down)

### *Thinner*

Fast or slow setting / attractive (volatile) substances which are mixed with the finished solutions.

### *Viscosity*

Viscosity, inner friction, that property of a liquid or a gaseous medium (fluids), which, during deformation, yields friction tensions in addition to thermodynamic pressure, working against the displacement of liquid or gaseous particles.

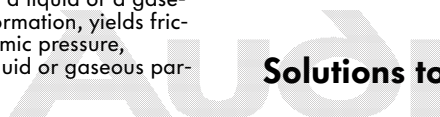
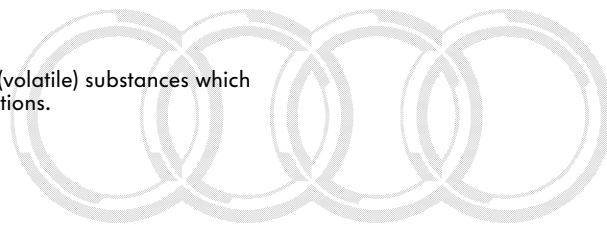

## Solutions to the test questions:

**1: A, C / 2: B / 3: A / 4: A, B / 5: A, C, D / 6: A, B / 7: A / 8: C / 9: A, B, C / 10: B / 11: A, C / 12: A / 13: C / D 14: A, B, C D / 15: A, B, D / 16: A, C, D**

Protected by copyright. Copying for private or commercial purposes, in part or in whole, is not permitted unless authorised by AUDI AG. AUDI AG does not guarantee the correctness of the information with respect to the correctness of information. Copyright © Audi AG.



